

Wireless World

RADIO AND ELECTRONICS

DECEMBER

1949

39th YEAR OF PUBLICATION

Directors: LILFEE & SONS LTD.

Managing Editor: HUGH S. POCOCK, M.I.E.E.

Editor: H. F. SMITH

Editorial Advertising and Publishing Offices:

DORSET HOUSE, STAMFORD STREET,
LONDON, S.E.1.

Telephone:
Waterloo 3333
(60 lines).

Telegrams:
"Ethaworld, Sedist,
London."

PUBLISHED MONTHLY

Price: 2/-

(Publication day: last Thursday of preceding month)

Annual Subscription: Home and Overseas, £1 6s. 0d.
U.S.A. and Canada, \$11.00

Branch Offices:

Birmingham: King Edward House, New Street, 2.

Coventry: 8-10, Corporation Street.

Glasgow: 26B, Renfield Street, C.2.

Manchester: 260, Deansgate, 3.

In This Issue

OUR COVER: Anti-Echo Chamber (See Page 503)

EDITORIAL COMMENT	467
SUPPRESSED AIRCRAFT AERIALS By G. E. Beck	468
MEASURING TURNTABLE SPEED FLUCTUATIONS By E. W. Berth-Jones	471
TELEVISION RADIO RELAY	474
SHORT-WAVE CONDITIONS By T. W. Bennington	476
HIGH-QUALITY AMPLIFIER: New Version By D. T. N. Williamson	477
TEST REPORT: EKCO MODEL CR61	480
WORLD OF WIRELESS	483
ELECTRONIC DIVERSITY SWITCHING By H. V. Griffiths and R. W. Bayliff	486
SUPPRESSING IMPULSE NOISE By D. C. Rogers	489
ELECTRONIC CIRCUITRY By J. McG. Sowerby	492
POINTER INSTRUMENTS By E. H. W. Banner	495
RECORDS UNDER THE MICROSCOPE	497
UNBIASED By Free Grid.. .. .	498
THIS AND THAT By "Cathode Ray"	499
LETTERS TO THE EDITOR	501
RANDOM RADIATIONS By "Diallist"	504
RECENT INVENTIONS	506

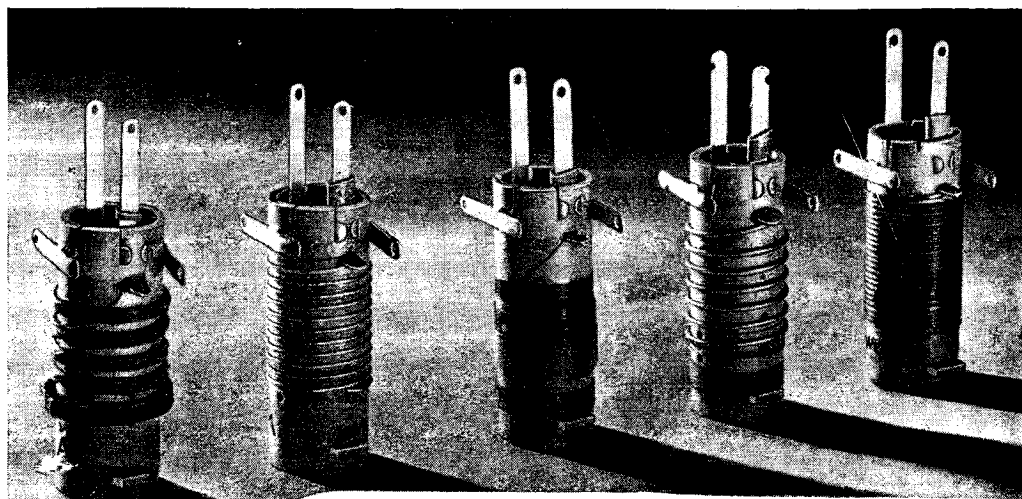

WEARITE

COIL PACKS

"P" COILS

... for Aerial, R.F., and Oscillator Tuning and readily available in all ranges.

WRIGHT & WEAIRE LIMITED

138 Sloane Street, London, S.W.1.

Telephone: SL0ane 2214/5.

Factory: South Shields, Co. Durham.

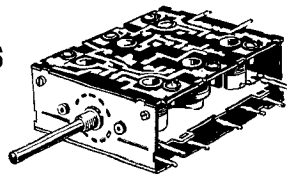

Send 6d. in stamps for the "Wearite" COILPACK Book of Technical Data and Circuits.

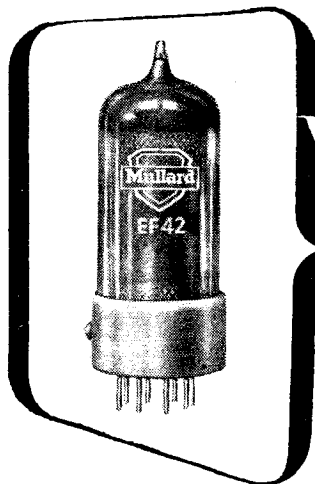

Valves and their applications

TELEVISION SYNCHRONIZING & TIME BASE CIRCUIT USING EF42, ECC34 & EL38. No. 3. SYNCHRONIZING PULSE SEPARATOR USING EF42.

The circuit of Fig. 1 with its associated waveforms in Fig. 2 will be recognised as part of the complete circuit in last month's issue of the "Wireless World".

The effectiveness of the time base synchronization profoundly affects the quality of the final picture. With the system of synchronization described in this series of reports a clean vertical edge and steady interlace are secured even in the presence of considerable interference, thus realising the full benefits of high definition obtained from specially designed signal circuits.

The process of synchronization is achieved in four major stages. In the first stage a slicing action takes place in which the composite video signal is truncated with the elimination of the picture signal and the tips of the synchronizing pulses which contain noise and interference.

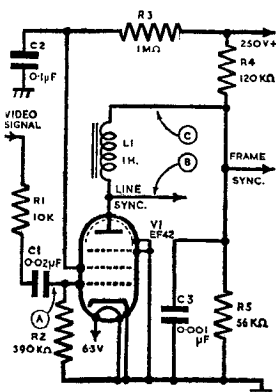

FIG. 1.
CIRCUIT OF FIRST LIMITER
IN SYNCHRONIZING PULSE
SEPARATOR.

corresponding to the chain of eight frame pulses, is passed on and other pulses, corresponding to the line pulses, are eliminated.

In the circuits discussed these stages are somewhat inter-related but the conception of the four steps will assist in following the more detailed description of the circuits which is given in the additional notes and next month's advertisement.

The first limiter (see Fig. 1) has a double clipping action by driving the EF42 well into grid current on the tips of the pulses and having a sufficiently short grid base so that the base of the pulses and the vision signal are beyond cut-off. The inductor L1 causes the valve to bottom as if it had a very large resistive anode load which gradually decreases in value during the

In the second stage, the synchronizing pulses are fed to the line time base in such a way that the time base is synchronized or fired at the correct instants of time by the leading edges of the pulses.

In the third stage, amplitude differentiation of the line pulses and the chain of frame pulses is obtained. In the transmitted signal the differentiation is one of pulse length.

The fourth and final stage is a further slicing operation. The results of the third stage are sliced so that a single pulse of about $400\mu\text{s}$ duration,

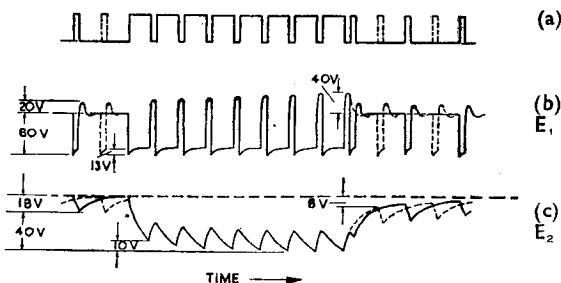

FIG. 2.
WAVEFORMS OF POTENTIAL ASSOCIATED WITH THE FIRST
LIMITER STAGE OF THE SYNCHRONIZING PULSE SEPARATOR.

- (a) Transmitted Synchronizing Pulses.
- (b) Waveform at Anode of Valve VI. (E_1)
- (c) Waveform showing Amplitude Differentiation of Frame and Line Pulses (at point C, Fig. 1). (E_2)

period of a synchronizing pulse. This has the effect of increasing the limiter base (the range of grid potential between cut-off and bottoming) during the pulse and the maximum amount of noise and interference is cut off at the beginning of the pulse period when the line blocking oscillator is fired and is taking current. If a large value resistor were used instead of an inductor to obtain this short limiter grid base the frame pulses would not be effectively developed across the capacitor C3 for lack of sufficient anode current. With the circuit employed large frame pulses are obtained, the amplitude of the first being practically equal to that of the last.



Reprints of this report from the Mullard Laboratories, together with a fuller description of the circuit, may be obtained free of charge from the address below.

MULLARD ELECTRONIC PRODUCTS LTD.,
TECHNICAL PUBLICATIONS DEPARTMENT,
CENTURY HOUSE, SHAFESBURY AVE., W.C.2

(MVM1108)

Wireless World

VOL. LV. NO. 12

DECEMBER, 1949

RADIO AND ELECTRONICS

Monthly Commentary

G.P.O. AND INTERFERENCE

A CORRESPONDENT whose letter is printed elsewhere in this issue draws attention to a matter that has become of increasing importance since the Wireless Telegraphy Act was passed.

As everyone knows, the General Post Office has long undertaken to investigate complaints of interference with broadcast reception, and to give help, within its power, in removing the cause. It is less generally known that this help has been mainly restricted to dealing with interference affecting reception of B.B.C. stations, though we believe that no official pronouncement has been made to support the statement, quoted by our correspondent, that reception of foreign broadcast stations is no concern of the P.O. engineers.

Even before the passing of the Wireless Telegraphy Act such an attitude seemed hardly tenable, or at least highly arbitrary. In law, the listener pays his licence fee, not for the B.B.C. programmes, but for the use of a very small part of the Postmaster-General's monopoly in wireless telegraphy. If the licensee chooses to listen to foreign stations, he is surely entitled to equal protection within reason, though it would clearly be unreasonable to expect a signal of excessively low field strength to be effectively protected.

Although the Postmaster-General's obligations to protect his broadcast listener licensees may not be sensibly affected by the passing of the Wireless Telegraphy Act, his powers to afford effective protection are now greatly increased. These powers should, we submit, be wielded in such a way as to encourage the development of broadcast listening in every direction. The P.M.G. has always had authority to curb encroachments on the broadcast band by stations licensed by him, but it would seem that British beacon stations do at present interfere with the reception in this country of non-

B.B.C. stations. As to machine-made interference, it is hoped that the new powers of suppression will be wielded in such a way as to confer the greatest possible benefit to all, and not in a dictatorial or arbitrary manner.

QUICK-TUNING SYSTEMS

COMMENTING last month on the trend of design of broadcast receivers, as exemplified at the Olympia Exhibition, we referred to a tendency to provide the simplest possible form of tuning for the selection of B.B.C. programmes. This, as we said, is a change we have long expected to see. Domestic broadcasting is, at present, organized on a basis of three programmes—or two programmes for a large proportion of the population. Therefore there would seem to be a need for some quick and easy change-over device from one to the other, irrespective of the complexity or otherwise of the main tuning system of the receiver—and also irrespective of the skill of the user.

A surprisingly large number of readers seem to agree with the desirability of this innovation. A few of our correspondents, it must be admitted, chide us gently for detecting a summer when only one or two swallows in fact exist; they say, in effect, that the very small number of sets in which this feature is included hardly warrant its being hailed as a trend in design. Be that as it may, no dissentient voice is raised against the value of the feature, and our regular contributor, "Cathode Ray," suggests the general public lack the spirit to demand a facility of which he assumes the value to be self-evident. We think, now that the ordinary listener has been shown that switch selection of the main B.B.C. programmes is practicable, he will soon expect to find it in every type of receiver, at every price level.

SUPPRESSED AIRCRAFT AERIALS

Various Methods of Reducing "Drag"

By G. E. BECK, B.Sc., A.M.I.E.E.

(Marconi's Wireless Telegraph Company)

TABLE OF AERONAUTICAL RADIO AND RADAR SYSTEMS

Service	Frequency Coverage Mc/s.	Type of Aerial
Automatic direction finding	0.15 to 2.0	Sense aerial and rotating loop.
M.F. weather reports and "Consol" navigation.	0.15 to 2.0	Reception only, omni-directional, vertically polarized.
H.F. communication	2.0 to 20.0	Transmission (150W) and reception, omni-directional.
V.H.F. communication.	118 to 132	Transmission and reception, vertical polarization.
Instrument landing system. Marker.	75	Reception, downward-looking.
Instrument landing system. Localizer.	108 to 118	Reception, omni-directional, horizontal polarization.
Instrument landing system. Glide path.	329 to 336	Reception, forward-looking, horizontal polarization.
Secondary radar homing system. (Rebecca).	208 to 234	Directional aerials for vertically polarized transmission and reception.
Radio altimeters.	1,600 to 1,700	Downward-looking, transmission and reception.
Cloud and collision warning radar.	10,000	Narrow rotatable beam transmission and reception.

ONE of the principal ways of improving the overall performance of aircraft—and hence increasing the payload of civil aircraft—is to reduce "drag" to a minimum, by eliminating or suppressing external fittings on wings and fuselage. Conventional radio and radar aerials have proved serious offenders in this matter of "drag," so that the immediate need has been to produce aerials which do not project beyond the normal skin of the aircraft. For example, by eliminating 1 lb of "drag" from a medium-sized airliner whose cruising speed is 230 knots, the pay-load can be increased by 20-30 lb, and this might well be achieved by replacing an existing external aerial with a suppressed aerial. Again, by suppressing all the aerials on a modern airliner it is possible to eliminate 25 lb or more of "drag." Apart from this, suppressed aerials have obvious mechanical advantages at high speeds, when it is difficult to secure such things as projecting rods or wires.

Types of aerial.—Aeronautical radio services use frequencies in a great many wavebands. Some idea of the complexity of the problem this presents to radio designers and engineers can be obtained from a study of the table. This table gives some of the services concerned, the frequency coverage of those services, and the types of aerial that the fre-

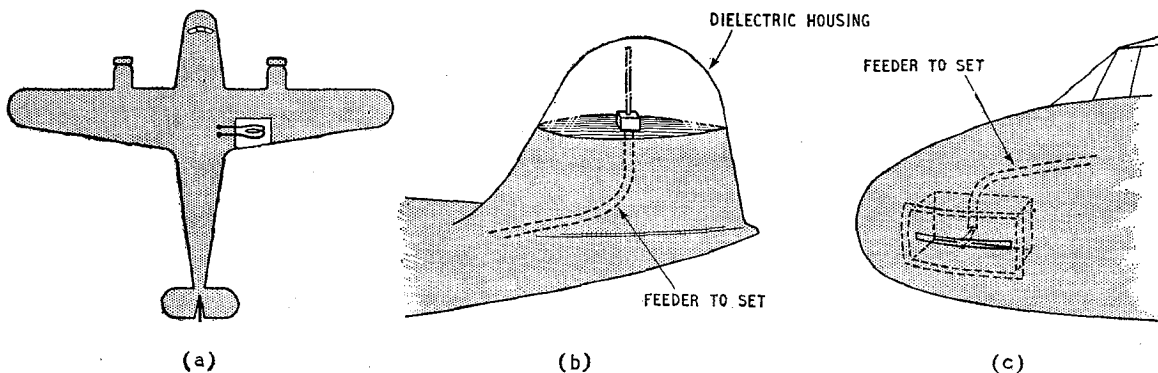

Fig. 1. Types of suppressed aerial: (a) wing radiator, (b) buried aerial, (c) slot aerial.

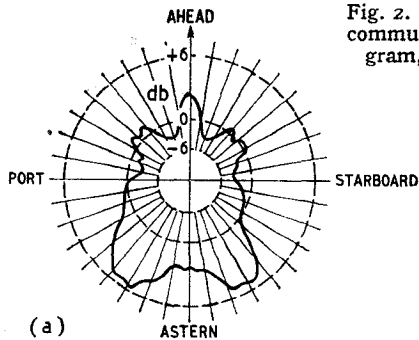
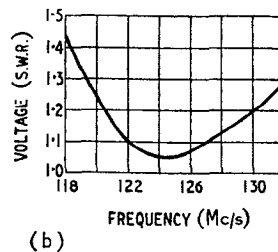

Fig. 2. Buried rod aerial for v.h.f. communication: (a) polar diagram, (b) measured bandwidth.



quencies demand. It is by no means a complete list, but all the items on it—or their equivalents—are required by aircraft flying on the international air routes of the world.

To cover such a wide range of frequencies it is obvious that the aeriels of an aircraft must be of diverse forms, and some of the possibilities of suppressing these aeriels are discussed below.

Wing radiators (Fig. 1 (a)).—Below 20 Mc/s the conventional aeriels are trailing wires up to 200ft in length, or a fixed horizontal wire carried a few feet above the fuselage. The trailing type has a high loss resistance and the fixed wire a very low effective height, but it is not easy to produce as good a radiator within the aircraft structure. This structure is nearly always wholly metallic and the insulation of an appreciable part of it is not generally possible for mechanical or structural reasons.

One interesting approach to this problem is to excite the whole structure of the aircraft as an aerial.¹ If the aircraft span is considered as a single "turn" secondary of a transformer whose primary is a small coil at the root of the wing, there will be some transference of energy which will be radiated. The same method can be applied to the excitation of the fuselage, and, if the wing and fuselage are energized in the correct phase relation, a "crossed dipole" system is produced from which the radiation pattern will be more or less uniform in azimuth.

Considerable success has been reported for this method over the frequency range for which the wing span is not less than 0.2 wavelengths (*loc. cit.*). Communication ranges equal to those

with a fixed wire aerial have been obtained, and the radiation pattern deviates from circular by less than ± 2 db.

Buried aeriels (Fig. 1 (b)).—Rod or loop aeriels may sometimes be mounted in a way which does not cause any additional "drag" if a small part of the aircraft skin (such as the tip of a wing or a tail fin) is made from an insulating material. This is of value in the frequency band 100-200 Mc/s where an aerial approaching a quarter-wave in length can be housed inside a section not exceeding one or two feet long. Fig. 2 shows the polar diagram and measured bandwidth of a buried rod aerial for v.h.f. communication. It will be

seen that the polar diagram variations do not exceed ± 6 db and the voltage standing wave ratio is below 1.5:1 over the band. This compares favourably with an external aerial of the whip type.

Another example of a buried aerial is the rotating loop for medium-frequency direction finding. By the use of a dust-iron core sufficient pick-up is obtained from a shallow loop mounted in a tray below the aircraft skin. The skin of the aircraft is continued over the loop aperture with insulating material. The photograph (Fig. 3) also shows a symmetrical arrangement of rods inside the aperture which gives the vertical signal for sense determination.

All parts of the aircraft surface carry some mechanical stress and so the material for covering these aeriels must possess good mechanical as well as electrical properties. This need is met by a laminate of woven glass cloth bonded together with a resin of good dielectric properties.

Slot aeriels (Fig. 1 (c)).—It has been shown² that a rectangular slot cut in a metal plate will radiate if fed from an energized cavity placed behind it, or by a transmission line directly connected to opposite sides of the slot. The slot exhibits resonance similar to a half-wave dipole if it is a half-wavelength long at the operating frequency. If its width is small compared with a wavelength the radiation is polarized in a direction perpendicular to the length of the slot. (The slot is filled with a woven-glass type dielectric, otherwise the opening would defeat the purpose of suppressed aeriels and create "drag.")

Radiation will take place from both sides of the sheet carrying the slot so that even when direct connection to the transmission line is used, as in Fig. 1 (c), a resonant cavity must be placed behind it to prevent unwanted radiations into the aircraft. The size of this cavity and the length of the slot which can be cut without weakening the structure make the applications to aircraft useful only for wavelengths less than 2 metres (frequencies greater than 150 Mc/s). A pair of directional receiving aeriels formed by slots on

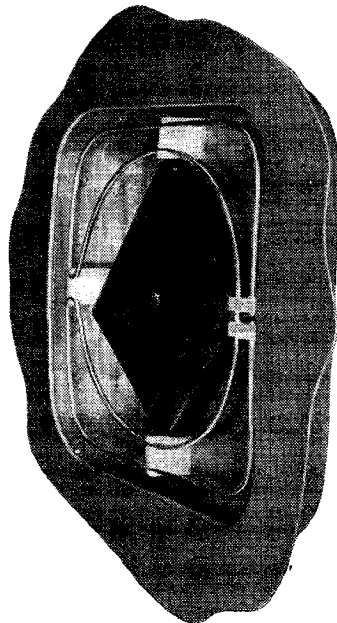
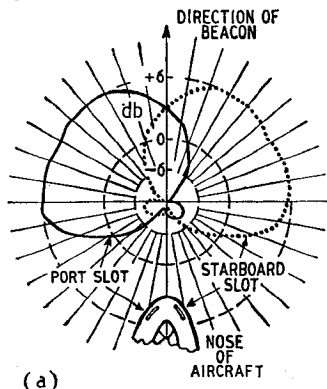

Fig. 3. Recessed iron-cored D/F loop and sense aerial; external view.

Suppressed Aircraft Aerials—

either side of the aircraft nose will give an equisignal course for homing on a radar beacon (Rebecca-Eureka system). Fig. 4 shows the polar diagram and bandwidth of this type of aerial. The incoming signal energizes the slot which, in turn, energizes the cavity behind it. Within the cavity



an aircraft would be tested in the model at 2,400 Mc/s. The model can be raised sufficiently clear of the ground to simulate actual flying conditions. Fig. 5 shows such an arrangement.

A full-sized mock-up consisting of a framework formed in the shape of an aircraft nose is generally used to find the im-

Fig. 4. Directional slot aerial: (a) polar diagram, (b) measured bandwidth.

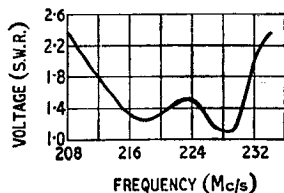

pedance characteristics of the aerials. The metal skin is represented by close-mesh wire netting over the framework. The figures thus obtained are those at ground level, but the change in impedance when flying is generally small enough to be neglected.

Team work in design.—Suppressed aerials are so much a part of the structure of an aircraft that the radio engineer and the aircraft designer must begin collaboration at a very early stage. The alternative designs which can be suggested, and the structural problems they raise, can be adequately resolved only while the aircraft is still on the drawing board. The possibilities of fitting suppressed aerials to machines which are already constructed are very limited.

This situation is now realized by the aircraft and radio manufacturers, and the aircraft of the future will carry suppressed aerials which are the result of good team work by the design staffs of both industries. Care must also be taken to see that potential users of the aircraft have been consulted at this early stage, so that the radio services they are likely to require may be catered for.

In all cases the performance of the suppressed aerials must not be inferior to that of the original external aerials which they are intended to replace, both as regards polar diagram and impedance variations within the specified frequency band. The most desirable terminal impedance depends on the particular equipment concerned, and so it is of the utmost importance that characteristics of aircraft aerials should be properly standardized throughout the radio industry if the aerials are to be suitable for any changes in equipment that may be required.

It should be pointed out, however, that already this matter has been greatly assisted by the publication of recommended aerial feeders and characteristics by the Air Radio Panel of the Radio Communication and Electronic Engineering Association³.

References

- ¹ Johnson, W. A. "Recent developments of aircraft communication aerials." *J.I.E.E.*, Part IIIA, Vol. 94, p. 452, 1947.
- ² Booker, H. G. "Slot aerials and their relation to complementary wire aerials." *J.I.E.E.*, Part IIIA, Vol. 93, p. 620, 1946.
- ³ Report of Sub Panel "H." (*Minutes of Air Radio Panel meeting, R.C. and E.E.A.*, 6.10.47.).

Fig. 5. Scale model aircraft used for polar diagram measurements.



lies a probe which is energized by the cavity and provides receiver coupling.

Design methods.—One feature common to all these types of aerial is the dependence of aerial characteristics on the contours of the aircraft. The curvature of the metal skin surrounding a slot, the shape of a dielectric housing within which a rod aerial must be fitted, the presence of adjacent wings or tail fins; all have an effect on the aerial performance, so that the development of suppressed aerials must be based upon considerable experimental work.

A suppressed aerial which has been designed for one type of aircraft can rarely be used for any other type.

The final test of an installation is made on flight trials, but all the preliminary data can be obtained from experiments with models and full-size mock-ups of those parts of the aircraft which are concerned. The directional properties of an aerial can be gauged with considerable accuracy from a scale model of the aircraft and by using operating frequencies in proportion to the scale used.

Using a scale factor of 1/24, an aircraft of 100ft wing span would be represented by a model a few feet across and an aerial intended to operate on 100Mc/s in such

MEASURING TURNTABLE SPEED FLUCTUATIONS

By E. W. BERTH-JONES, B.Sc.
(E.M.I. Studios)

A Sensitive Method of Checking "Wow" and "Flutter"

ONE of the most distressing forms of distortion which can occur in the reproduction of a sound recording, particularly a recording of music, is that caused by speed fluctuations. When this takes the form of slow cyclic variations, it is usually known as "wow," whereas rapid fluctuations are commonly referred to as "flutter." Erratic, non-cyclic speed changes are frequently called "watering."

The precise measurement of these variations in speed has offered considerable difficulty. The ear is particularly sensitive to this form of distortion, and anybody with a reasonably good sense of musical pitch will notice quite small variations, often as small as a tenth of one per cent, on a sustained note. In high-quality equipment it is commonplace to maintain speed constancy to within a twentieth of one per cent, and in order to measure the residual error with any accuracy, it is necessary to have a measuring instrument with a sensitivity of the order of one hundredth of one per cent, or one part in ten thousand.

Moreover, it is not sufficient to measure slow changes in the mean speed over a complete revolution. It is necessary to make the measuring period as short as possible in order to get accurate information of any rapid flutter which may occur, but this makes very severe demands upon the measuring apparatus. Fortunately, due to the inertia of the turntable, it is unlikely that speed changes will take place very rapidly, and a measurement averaged over one-tenth of a revolution would appear to give a satisfactory compromise.

A method which has met with some success employs a phonic wheel mounted concentrically with

the turntable, the teeth of which are used to generate an alternating electrical signal whose frequency will be proportional to the speed of rotation. This frequency may then be measured by bridge methods with the required degree of accuracy, and will be an indication of the speed. To attain an accuracy of one part in ten thousand, each tooth of the phonic wheel must be cut with this accuracy of tooth spacing, which makes the wheel a very costly item. With a wheel of normally realizable accuracy, the method is excellent, though expensive, for the measurement of "wow," but it is useless for the more subtle forms of "flutter."

Change of Wavelength

For disc-recording purposes, a method which gives more reliable results at much lower cost consists simply of recording a continuous tone, at the same time playing back from a point slightly displaced from the point of application of the recording. It may safely be assumed that the oscillator producing the tone can be made to give a train of waves which are substantially identical in shape and spacing, to the required degree of accuracy. Methods of stabilizing oscillators have been described in the literature, and the problem becomes resolved into choosing the type which will maintain the required degree of constancy. The waveform is relatively unimportant, the governing factor being the precision of repetition.

The fundamental frequency of the reproduced wave may be measured as before, and if the speed is constant this will be identical with the oscillator frequency, since recording and re-

production are taking place at the same speed. If the rotational speed changes while the element is moving from the recording point to the reproducing point, the reproduced frequency will differ from that of the oscillator during the period of change. For instance, supposing that the disc is accelerating: the speed of an element when it passes the reproducer point will be higher than it was at the recording point, and the reproduced frequency will be correspondingly higher than that of the oscillator. This change in frequency can be made to give us a reading, not of the absolute speed, but of acceleration measured between recording and reproducer points. For normal cyclic variations, the amplitude of the speed change can be derived from this. It is unnecessary to measure the reproduced frequency directly. It may be compared with the original oscillator frequency on a ratio basis, or more conveniently on a difference basis, by means of beats. In the latter case, the beat frequency would be proportional to the acceleration.

Unfortunately, in practice, in any good recording system the accelerations to be measured have only a very low order of magnitude, so that a very high initial frequency has to be used in order to obtain a beat which will fall within a measurable range, and this high frequency may fall outside the limits of the recording system.

However, this method is capable of a modification which overcomes this limitation, and which can be made to yield a display which represents the speed deviation directly. For the purpose of this description, the method will be considered in its application to the measurement of flutter on

Measuring Turntable Speed Fluctuations—

78 r.p.m. gramophone recording. It is a simple matter to adapt it to other problems.

The first requirement is an audio-frequency oscillator capable of supplying a tone of known frequency, constant to within a tolerance rather closer than the errors it is required to measure. This is fed through the recording channel to the cutter head, which is mounted in position on the recording lathe which is to be tested. A pickup is also mounted on the machine, in such a manner that it will track the groove cut by the recording head, at a distance of a few inches behind it, preferably adjustable. The output of this pickup is amplified until it can be matched in level with a second output tapped off from the recording channel. The recording machine is adjusted to run at correct mean speed, either by counting the number of revolutions in a given time, or by stroboscopic methods.

Procedure

Cutting is now commenced, and the pickup is slipped into the groove, a little behind the recording point. Now if the turntable speed is constant, the output from the pickup will be, theoretically at least, a duplicate of the input wave, displaced from it only in time. Either by adjusting the oscillator frequency, or by moving the pickup mounting slightly, it is possible to arrange that both reach their maxima at the same moment, that is, they are in phase. Assuming no distortion of wave shape, the two outputs can be connected back-to-back, giving a resultant of zero.

Suppose now that the turntable speeds up, by a very small amount. Any individual wave peak, cut by the recording stylus, will now reach the reproducing point sooner, due to the increased speed of travel. This increase is very small, so that the saving in time is less than the duration of a single wave, but it is sufficient to ensure that the reproduced wave is now out of phase with the oscillator wave, and when the two are connected back-to-back, cancellation no

longer occurs. There is a residual resultant whose amplitude is a function of the change in speed, and which can be made to operate a meter. This is illustrated diagrammatically in Fig. 1.

Putting this in another way, supposing we set up the apparatus so that with correct mean turntable speed there are exactly 100 waves between recorder and reproducer points. If now the speed increases by, say, one tenth of one per cent, the wavelength will increase by one tenth of one per cent, and the length of 100 waves will increase by one tenth of one wave, which is 36° of phase difference, and easily measurable.

As an example of the dimensions involved, consider a gramophone recording turntable revolving at 78 r.p.m. The linear velocity of the groove under the needle point is given by

$$V = \frac{2\pi RN}{60} \text{ in/sec} \quad \dots (1)$$

where R is the radius of the groove, measured from the disc centre, and N is the speed in revolutions per minute. At a radius of about 4in, the linear velocity will be, say 30in/sec. If a 6,000 cycles per second tone is applied, then 6,000 cycles occupy 30in of arc on the disc, and the wavelength measured along the groove will be 0.005in. If now the spacing between recording and reproducing styli, again measured along the arc, is made exactly two inches, there will be exactly 400 waves between the two points, and the output will be in phase with the input.

Suppose now that the turntable speed is increased by, say, 0.01%, so that the linear velocity becomes 30.003in/sec. Now 6,000 cycles occupy 30.003in of arc, and the wavelength becomes 0.0050005in, so that there are now only 399.96 waves between the two points. The reproduced signal will be 0.04 of a wave in advance of the oscillator, which is a difference in phase angle of $0.04 \times 360^\circ$, equal to 14.4° , which is capable of giving a measurable output. At the present stage of the art, a speed fluctuation of 0.01%, which we have presumed, is generally considered to be quite inaudible.

It is worth noting here that this

measurement has been averaged over an arc of only 2in, on a circumference of 23.1in, that is, less than one-tenth of a revolution. The very high order of sensitivity of the method thus becomes evident.

General Relationships

Generalizing from this example, it may be seen that, if we designate the number of waves between the two styli as W, and the distance along the arc in inches as D, then

$$W = D/\lambda \quad \dots (2)$$

where λ is the wavelength measured along the arc, in inches.

From (1) we have seen that

$$V = \frac{2\pi RN}{60}, \text{ and we have also}$$

$$V = f\lambda \quad \dots (3)$$

where f is the applied frequency.

Hence, the number of waves between the points is given by

$$W = \frac{60Df}{2\pi RN} \quad \dots (4)$$

Letting the suffix 0 denote the desired condition, for which the system is set up, we have N_0 as the mean speed, in revolutions per minute, and W_0 as the number of waves between the points when the speed is correct (which may be made any integral number of half wavelengths.)

The phase difference producing output, measured in degrees, will be the angle ϕ , where

$$\phi^\circ = 360(W_0 - W) \quad \dots (5)$$

or, measured in radians

$$\phi_{\text{rad}} = 2\pi(W_0 - W) \quad \dots (6)$$

Substituting from (4), this latter becomes:—

$$\phi_{\text{rad}} = 60f \frac{D}{R} \cdot \left(\frac{1}{N_0} - \frac{1}{N} \right) \quad \dots (7)$$

$$= 60f \cdot \frac{D}{R} \cdot \frac{N - N_0}{NN_0}$$

$$= - \frac{6f}{10} \cdot \frac{D}{R} \cdot \frac{n}{N}$$

where 'n' is the percentage change in speed.

Since the actual change of speed is very small, it is permissible to write N_0 for N in this equation, which then becomes

$$\phi_{\text{rad}} = - \frac{6f}{10} \cdot \frac{D}{R} \cdot \frac{n}{N_0} \quad \dots (8)$$

From equation (8) it will be seen that the phase angle changes in direct proportion to the percentage change of speed, so that any meter suitable for measuring the phase difference between the

Fig. 1. Illustrating the principle underlying the method of measurement.

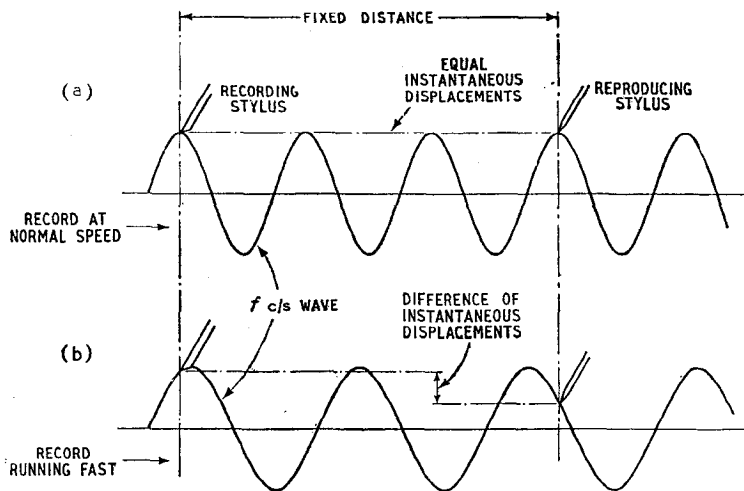

two waves may be calibrated directly in percentage change of speed.

If the phase change exceeds π radians (or 180°), the output will commence to fall again, and it is not, therefore, possible to deal with phase variations greater than this. For illustration, Fig. 1(b) shows a phase change of about 280° from the peak of the third wave measured from the recorder point, which is the initial condition shown in Fig. 1(a). The meter reading for 280° ($360^\circ - 80^\circ$) would be indistinguishable from that obtained for 80° , and the amount of flutter would therefore be underestimated. This can, however, easily be dealt with by reducing the oscillator frequency, so that the wavelengths become larger, and the phase changes proportionately smaller. For large amplitudes of flutter, therefore, we require a low frequency, and for high sensitivity a high frequency, as equation (8) suggests.

Radial Tracking Essential

In practice, there remain several difficulties in the method outlined. For example, for a linear relationship between phase angle and percentage speed variation to be maintained, it is essential that the ratio D/R remains constant, unless readings are always taken at one particular radius. This involves precisely radial tracking of both recording and reproducing heads, which is difficult to achieve, and

which leads to mechanical complications at small radii. Also this method is confined to disc recorders.

It may, however, be extended and rendered almost universal in its application by the substitution of magnetic recording methods. If an annular magnetic track is substituted for the disc record, and the cutting head and reproducer are replaced by a magnetic recording head and replay head, the validity of the method remains unaltered. If, in addition, an erasing head is added, to wipe out the wave after it has passed the replay head, the same piece of track will return fresh and unmodulated under the recording head again and again, while the positions of the various components remain unchanged. With some forms of phase-meter the waveform from the replay head can be allowed to depart considerably from the sinusoidal shape, particularly near the peaks, and it is therefore quite permissible to use d.c. for erasing and for recording bias, with considerable simplification of equipment. A magnetic track may be deposited on the underside of a gramophone turntable, for instance, and the heads mounted below with their gaps arranged radially, and just clear of the track. In order to obtain a strong enough signal in spite of this clearance, the recording head may be heavily overloaded, again because we are indifferent to waveform. This arrangement may

be left *in situ*, and used to monitor the flutter on an attached meter while recording is in progress.

For the measurement of the phase changes in the laboratory, it is sufficient to feed the reproduced output to one input of a double-beam oscilloscope, the other input being fed from the oscillator output, and used to synchronize the time base. Then the difference in phase between the two traces can be read off the screen directly. If the gain of the oscilloscope is turned up so that the wave peaks fall outside the screen area, amplitude variations will be found to be less disturbing. For routine measurements, a phase-meter giving a direct scale reading has been devised, to simplify checking by non-technical operators.

Sense Discrimination

As so far described, it will no doubt be noticed that there is no discrimination between acceleration and retardation. Both positive and negative speed changes will produce a positive reading on the meter. However, by using a slightly different oscillator frequency, we can arrange that the correct mean speed shows a phase-shift of 45° , instead of zero, and the meter will give a half-scale reading, which can be calibrated as zero fluctuation. Then a slightly lower speed will give a lower reading, and a higher speed a higher reading on the meter, thus showing whether any flutter which may be present represents an acceleration or otherwise.

One of the great advantages of this method is that the sensitivity of the system can be so easily varied, simply by changing the frequency of the applied tone. Further, the magnetic track method is capable of resolving very much smaller deviations than others hitherto used, and its low cost and absence of loading enable it to be fitted to every channel in a commercial recording system, and to be used during actual recording, instead of only as an occasional test.

For film recording, a magnetic

(Continued at foot of following page)

TELEVISION RADIO RELAY

London - Birmingham Link

A DEMONSTRATION of the London to Birmingham radio-relay link was given on 3rd and 4th Nov. Designed and constructed by the General Electric Co. to a performance specification of the Post Office, the link comprises two terminal stations and four relay stations at Harrow Weald, Dunstable, Blackdown and Rowley Regis. It provides a single-vision channel which can be used in either direction; that is, it can be employed to send a picture from London to Birmingham or from Birmingham to London. When the remaining equipment is installed two reversible channels will be available and then it will be possible to send pictures simultaneously in both directions.

It is claimed that this link is the first television relay link in the world which is installed on a permanent basis and which has been designed throughout with reliability as a prime consideration. Many other television relaying schemes have been tried, but all have been primarily experimental in nature.

In this link all apparatus is duplicated. There are duplicate transmitters, duplicate receivers and duplicate power supplies. In the event of a failure, therefore, the spare can be brought immediately into service with the briefest of interruptions.

The relay stations are un-

attended and are operated by remote control from London or Birmingham. In the event of a major fault in such a station the unit affected is automatically taken out of circuit and replaced by its duplicate. At the same time the terminal stations are automatically notified. The change-over from one unit to another at a relay station can also be carried out at any time by an operator at one of the terminal stations, who has only to press a button to effect the change. Even power failures are allowed for. The relay stations are normally fed from the grid; should the supply fail, a petrol-electric generator is automatically started up and the station is again operating within two minutes!

Because of the great flexibility of control provided, the control circuits are exceedingly complicated and embody some 3,000 relays! The radio side of the equipment almost tends to be buried in the welter of control and indicator equipment—which is a pity, since it is highly ingenious.

Transmission is carried out on about 30cm. Frequencies of 870 Mc/s and 890 Mc/s are used and a change from one to the other is made at each relay station. At the terminal station the v.f. signal, containing frequencies up to 2.7 Mc/s, is used to modulate a 34-Mc/s carrier in frequency, the deviation being ± 1.5 Mc/s.

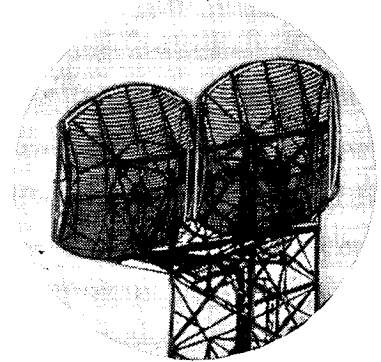

A pair of mirrors at a terminal station.

The modulated 34-Mc/s carrier varies in frequency between the limits of 32.5 Mc/s and 35.5 Mc/s and after amplification it modulates in amplitude a second carrier of, say, 904 Mc/s. The result is a 904-Mc/s carrier with sidebands centred on $904 \pm 34 = 938$ Mc/s and 870 Mc/s. The sidebands vary in frequency in accordance with the vision signal over the range of ± 1.5 Mc/s or 936.5–939.5 Mc/s for one set and 868.5–871.5 Mc/s for the other. Band-pass and band-stop filters allow the 868.5–871.5-Mc/s band to pass to the aerial and prevent the other frequencies from doing so.

I.F. Amplification

At a relay station the signal on, say, 870 Mc/s is received and passed to a crystal mixer and brought down to 34 Mc/s by the ordinary superheterodyne technique. It is then amplified in a somewhat elaborate i.f. amplifier of 10-Mc/s bandwidth which is provided with a.g.c. Then, just as in a terminal station, it is brought back to signal frequency

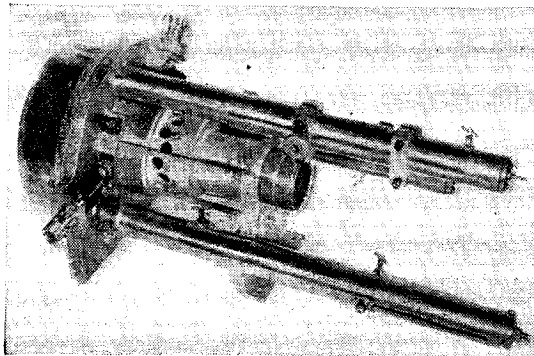

Typical r.f. component.

Measuring Turntable Speed Fluctuations.
(Continued from foot of preceding page)
track coated on to the film base allows fluctuations in speed of the film itself to be checked, and forms a valuable tool for the investigation of sprocket ripple.

A disc coated with magnetic material may easily be fitted to the sound drum of film recording systems, and the method is therefore equally applicable to this medium, or in fact to any problem involving the measurement of very small speed fluctuations.

by modulating an appropriate frequency. If the input is at 870 Mc/s, as in the example, the output is at 890 Mc/s and this can be obtained by modulating a 924-Mc/s carrier. At the next relay, the input is at 890 Mc/s and the output at 870 Mc/s, and so on. The arrangement is sketched in the block diagram.

The locally generated frequencies are derived from a crystal oscillator of high stability and by arranging for both signal frequencies to lie on the same side of the local frequencies, their frequency difference is virtually independent of any drift.

Station Details

Coaxial circuits are used at signal frequency with triode valves. The transmitter output is 10W and the gain in a relay station is about 70db. Dipole aerials are used with reflectors, some 10ft by 14ft, giving about 28-db gain. The beam width to the half-power points is about 3° in elevation and 5° in azimuth. The reflectors are constructed of light alloy tubing and the tubes contain heating elements for de-icing.

During the demonstrations the relay stations had temporary masts for the aerials and all equipment was at ground level. In the final installation all equipment apart from power supplies will be at the mast head and feeder losses of some 12db at present existing will be eliminated. The final mast-head apparatus for the double link is to be four mirrors, four receivers and four transmitters, the two last being housed in a "room" about 9-ft square. The height of the masts vary from 60ft to 120ft in the different relay stations.

Two items of the equipment deserve especial mention; a filter and a switch. The former is a

combined band-pass and band-stop filter which provides 70-db discrimination between the wanted and unwanted frequencies in the amplitude-modulation process. It is built of co-axial resonant circuits and two of the filters are shown in the photographs. There are three sections to the filter, A, B and C. The long tubes control the band-stop characteristics and relatively very short tubes opposite them control the band-pass characteristics. The sections A and C are alike, but the middle one, B, is of smaller diameter and has one-half the characteristic impedance of the end sections. These tubes have inner conductors and so form resonant lines; however, the dielectric is not uniform but consists of alternate short sections of air and polythene. By adopting such a series of abrupt discontinuities in the dielectric the length of the section has been reduced from the 10-ft required with air to something like 18in only. Screw "trimmers" are provided at the ends for adjusting the precise characteristics. Similar "trimmers" are also provided on the short tubes controlling the pass-band.

"Contact-less" Switch

The switch operates at radio frequency to switch the coaxial circuits of the transmitters and receivers. It has no contacts and operates by moving plungers into coaxial stubs. Two input (or output) coaxial lines are T-junctioned to a single outlet (or inlet). At the proper distance from the T on each inlet line a stub is fitted. Now the input impedance of such a stub depends on its length and on its termination. In this case the termination is a movable plunger and in its two extreme positions

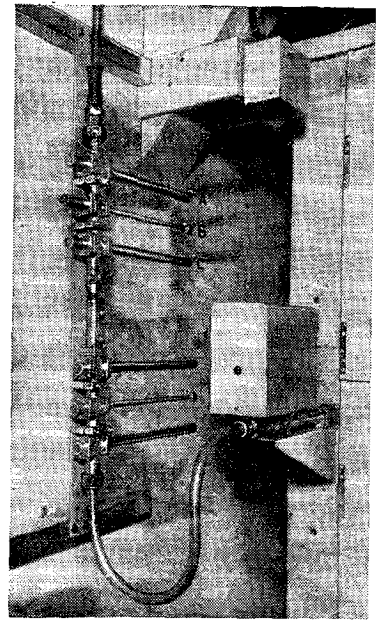

Two combined band-pass and band-stop filters are shown here.

it makes the input impedance tend to zero on the one hand and to infinity on the other. When the impedance is zero the line to which it is attached is short-circuited, whereas when it is infinity the line is unaffected by the stub.

The plungers in the stubs attached to the two lines move in opposite ways so that one line is blocked while the other is opened. Actually, two stubs $\lambda/4$ apart are used on each line to increase the attenuation in the "closed" line and some 70db is attained.

These "switches" are motor-driven and are used to change over the r.f. sides of the transmitters and receivers. They are used on the one hand to bring the duplicate units into circuit in the event of a fault, and on the other hand, to reverse the aerials to change the direction of transmission. This last feature makes great demands on the switches, as the output of the transmitter and the input of the receiver are necessarily coupled by any leakage through them. Some 70-db attenuation between paths in the switch is obtained and with the special circuitry employed the attenuation between aerials is kept down to 140db.

During the demonstration a

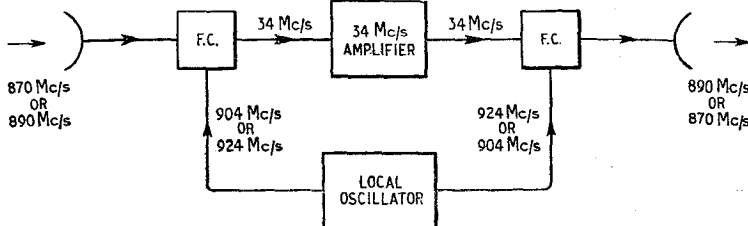

This block diagram illustrates the general arrangement of a relay station. The blocks labelled F.C. represent the frequency-changer on the receiving side and the modulation on the transmitting.

SHORT-WAVE CONDITIONS

October in Retrospect : Forecast for December

By I. W. DENNINGTON (Engineering Division, B.B.C.)



The receiver and its spare with front covers removed.

picture originating in London was seen on a monitor tube in Birmingham and no visible form of distortion could be detected. The picture was free from noise and interference and the definition was indistinguishable from what one is accustomed to in London. There is no doubt whatever that when Sutton Coldfield relays a London programme, Midland viewers will be under no disadvantage compared with Londoners.

All concerned with the design, development and construction of this link deserve the highest praise for a fine achievement.

EDUCATIONAL FILM

Putting Free Electrons to Work, a ten-minute film produced by Merton Park Studios Ltd. for the British Electrical Development Association, explains the thermionic effect and its application to the radio valve. A diagrammatic illustration is given of how electrons can be made to leave the surface of a conductor; then follows a simple explanation of the diode and triode, using conventional symbols. The photo-electric effect is similarly dealt with, and its application to the photo-electric cell. This film will be lent free, in either 16mm. or 35mm., to any responsible organization, on application to the General Manager and Secretary, British Electrical Development Association, 2 Savoy Hill, London, W.C.2.

DURING October the average maximum usable frequencies for these latitudes increased very considerably during the daytime, and decreased somewhat by night. This was in accordance with the normal seasonal trend, though, from the second week of the month onwards, the daytime increase was greater than had been expected. Daytime working frequencies were thus high: those as high as 28 Mc/s, for example, becoming regularly usable over most circuits. Night-time frequencies up to 9 Mc/s were still generally usable.

Sunspot activity was, on the average, slightly higher than during September, a fact which may account, in part, for the high m.u.f.s. The rate of incidence of Sporadic E did not, as might have been expected, decrease very much compared with the previous month.

October was a very disturbed month, particularly during its latter part. Ionospheric storms, all of them relatively severe, occurred during the periods 5th-9th, 14th-18th, 23rd-26th and 27th-30th. During the latter three of these storms, on the nights 14th-16th, 22nd-24th and 27th, the Aurora Borealis was widely seen in this country. Sixteen "Dellinger" fade-outs were reported as occurring during the month, the most intense being at 1406 on 2nd, 1318 on 8th, 1148 on 11th and 1145 on 13th.

Long-range tropospheric propagation occurred frequently between 1st and 10th of the month, and particularly on 6th and 7th, when Eiffel Tower television was widely received in southern England.

Forecast. — Day-time m.u.f.s in these latitudes during December should be somewhat lower than during November. This decrease is a usual feature at the extreme mid-

winter period, and it may, perhaps, be accentuated by decreasing sunspot activity. Night-time m.u.f.s should also decrease to their lowest winter values.

Long-distance working frequencies will still be relatively high by day, and those as high as 28 Mc/s should be regularly usable over most, but not all, circuits at the appropriate time of day, among which should be that to the eastern part of North America. At night only the lower short-wave frequencies will be generally usable, 7 Mc/s being about the highest regularly usable frequency for most circuits.

Ionospheric storms, though not usually particularly frequent during December, are apt to be troublesome after dark, because of the already low ionization prevailing during the winter night. At the time of writing it would appear that such disturbances are most likely to occur within the periods 1st-4th, 7th-9th, 16th-17th, 21st-22nd and 27th-30th.

The accompanying curves indicate the highest frequencies likely to be usable over four long-distance circuits.

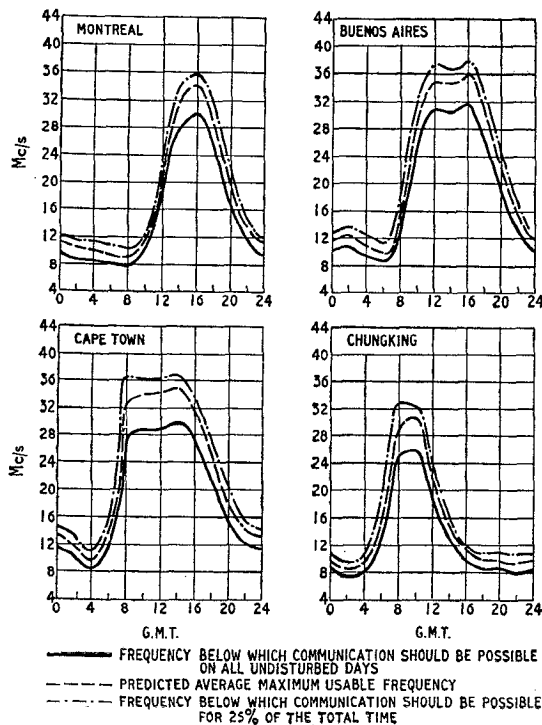

AT LAST— BETTER ALL-DRY MINIATURES

1R5
Heptode Frequency
Changer

1S4
Battery Beam Tetrode

1S5
Battery Diode Pentode

3S4
Battery Beam Tetrode

1T4
Battery Pent. Vari-Mu

3V4
Battery Beam Tetrode

Type Number	Application	Heater		Anode Voltage Normal	Screen Voltage Normal	Grid Voltage Normal	Anode Current mA	Screen Current mA	Impedance Ohms	Mutual Conductance mA/V	Optimum Load Ohms	Power Output Watts
		Volts	Amps.									
1T4	Batt. Pent. Vari-Mu	1.4	0.05	90	67.5	0/-16	3.5	1.4	500,000	0.9	—	—
1R5	Heptode F.C.	1.4	0.05	90	67.5	0/-14	1.6	3.2	600,000	300*	—	—
1S4	Batt. Beam Tetrode	1.4	0.1	90	67.5	-7	7.4	1.4	100,000	1.58	8000	0.27
1S5	Batt. Diode Pentode	1.4	0.05	90	67.5	0	1.6	0.4	600,000	0.63	—	—
3S4	Batt. Beam Tetrode	1.4 2.8	0.1 0.05	90	67.5	-7	7.4	1.4	100,000	1.58	8000	0.27
3V4	Batt. Beam Tetrode	1.4 2.8	0.1 0.05	90	90	-4.5	9.5	2.1	100,000	2.15	10000	0.27

* Conversion Conductance in Micromhos.

GREATLY advanced engineering techniques have enabled us to produce *ALL-DRY* Miniatures that are better in every way. Every valve is individually **RECEPTION TESTED** and bears this identifiable seal. **BRIMAR** *ALL-DRY* Miniatures are suitable for every modern All-Dry Portable. Full details of their characteristics are shown in the table above.

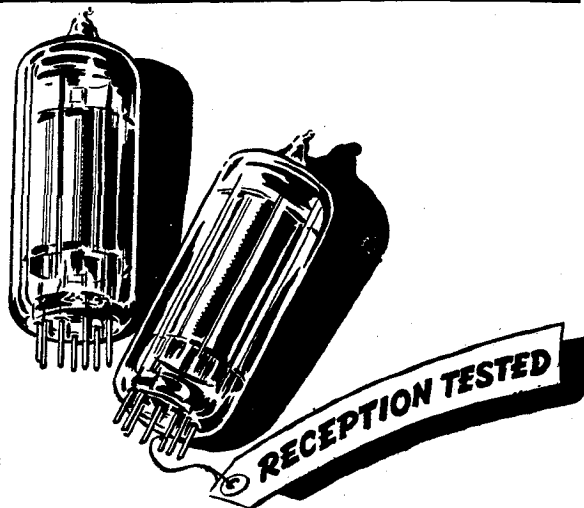

BRIMAR
ALL-DRY MINIATURES

STANDARD TELEPHONES AND CABLES LIMITED, FOOTSCRAY, SIDCUP, KENT.



A new approach to "High Fidelity" ...

and the coming of "New-True Fidelity"

PERHAPS no phrase in sound reproduction has been more loosely used in the past than "high fidelity." What some people would term high-fidelity reproduction caused others to shake their head. Obviously, ideas and ideals of fidelity were measured by differing standards. What, then, is "true fidelity"? Fortunately, this can accurately be measured and graphically expressed, but we have to seek the assistance of a very critical science—that of acoustics—which provides objective rather than subjective answers.

Here we are concerned more particularly with the reproduction of sound via an electrical pick-up. The authority of acoustic science has laid down a performance which it regards as ideal, but naturally, one that is unconcerned with the practical limitations which beset the manufacturer. For matters of cost and usage are no concern of the theorist. Indeed, the manufacturer could produce a pick-up with the approved ideal response, but such an instrument might cost, say, twenty-five guineas; and again it is conceivable that it would be so fragile as to preclude its use in the home. Further, even given a pick-up with the ideal response, and built on the most robust lines, its actual reproduction is still limited by the characteristics of commercial recordings. A practical pick-up must be capable of being used with a wide range of equipment, each item of which has its own idiosyncrasies. So the manufacturers' problems multiply, and a compromise of some kind is necessary.

The Quest ...

A year ago, however, after long experience in the design and mass production of pick-ups, Cosmocord Limited were convinced that an entirely new approach was essential. The easy way might have been to set a new, good, practical standard and say "This is high fidelity, and you ought to like it."

But the honest approach starts the other way round, viewing everything from the users point of view and the while, stimulating research at every step. That was the Cosmocord way.

And the Conclusions ...

The most important conclusions were:

- (1) That the average user does not want to spend time and money finding suitable equalising networks, etc. The pick-up must be a success from the word "go."
- (2) he wants his records to last—the pick-up must, therefore, cause the minimum possible wear.
- (3) he wants the pick-up to be robust enough to withstand even the most careless of handling.
- (4) and lastly, he wants the pick-up at a price he can afford.

Moreover, defects such as high tone-arm resonance, high needle-tip impedance and high tracking weight, excessive needle talk, reproduction of motor rumble and tracing distortion in the upper register, all these must be eliminated. So with these considerations in mind *acos* research set about developing the ideal pick-up—and the result is the GP.20.

Stage by Stage Achievement

First the stiffness of the assembly was reduced until the pick-up satisfactorily tracked commercial records at seven grams. Then, because warped records or badly aligned turntables and badly sprung motors might cause the pick-up to jump grooves, the tracking weight was deliberately increased to 13-14 grams. This extremely low needle pressure, coupled with the use of a flexible, sprung permanent sapphire stylus, reduces record wear to an absolute minimum, thus ensuring vastly longer life to records. Further, this flexibility of the assembly makes the unit virtually damage-proof.

Needle talk, tracing distortion and distortion due to "pinch effect," were greatly reduced by increasing the vertical compliance of the assembly until it was little less than the lateral compliance. The outstandingly good frequency-response was achieved by making the crystal assembly appear as a terminated mechanical transmission line, and arranging that the terminating section would give pre-emphasis of approximately 6 db per octave above 1,000 cps. This resulted in the working pick-up characteristic from commercial recordings (turn-over at 250 cps) being substantially flat from 20 to 250 cps, dropping approximately 6 db between 250 and 1,000 cps, and flat beyond that frequency up to 9 Kcs, the response falling above this frequency.

The pre-emphasis between 250 and 1,000 cps provides an automatic bass boost, *eliminating equalising circuits of any kind*. The frequency response was set flat to 9,000 cps, as being completely adequate to give the best reproduction from commercial records.

The output of the GP.20 is more than half a volt at 1,000 cps, and sufficient to load fully any domestic set or amplifier.

The tone-arm design is unique in that it is supported on a single needle point, thereby reducing lateral and vertical friction to the barest possible minimum. Torsional arm resonance is eliminated.

Finally—the Cost ...

Last, but not least, is the cost. The list price of the GP.20 in Great Britain is 50s. plus 21s. 5d. purchase tax. So *acos* research and *acos* mass production techniques, utilising the most efficient piezo-electric assembly, have produced an instrument comparable in price with ordinary pick-ups, but with a laboratory performance. Indeed a justification of the new approach to "high fidelity" reproduction, since it produced the GP.20 and achieved what we like to term "New-true Fidelity"—for that, assuredly, it provides.

COSMOCORD LIMITED • ENFIELD • MIDDLESEX

HIGH-QUALITY AMPLIFIER : New Version

Design for a Radio Feeder Unit

(Continued from page 427
of November issue)

THE preceding articles in this series have described amplifier, tone compensation and gramophone pre-amplifier units which are capable of driving a loudspeaker from the output of a pickup or a radio receiver. The design of a radio receiver which would be suitable for use under the varied reception conditions which exist in the populous parts of the country, and which at the same time could be constructed simply and with certainty of results, would be a difficult undertaking. In addition, such a receiver would be unnecessarily

By **D. T. N. WILLIAMSON**

(Ferranti Research Laboratories)

complex for the needs of that section of the community which lives within the primary service area of high-powered twin-wave transmitters, and which desires only to receive transmissions from these by the simplest possible means.

In order that the units described in the series should form a complete domestic sound installation, it is proposed to outline the design of a small two-stage receiver suit-

able for the reception of medium-wave transmissions within the primary service area. The type of receiver to be described gives satisfactory results where the spacing between the carrier frequencies of the principal transmitters is high, say 200 kc/s. It is not suitable for use in districts where closely-spaced powerful transmissions exist, or where interference is severe. The receiver circuit is offered as an indication of the general lines on which to proceed, and is capable of being adapted to individual requirements and conditions.

Fig. 20. Circuit diagram of local station radio receiver. Positions of selector switches for pre-set tuning shown at X.

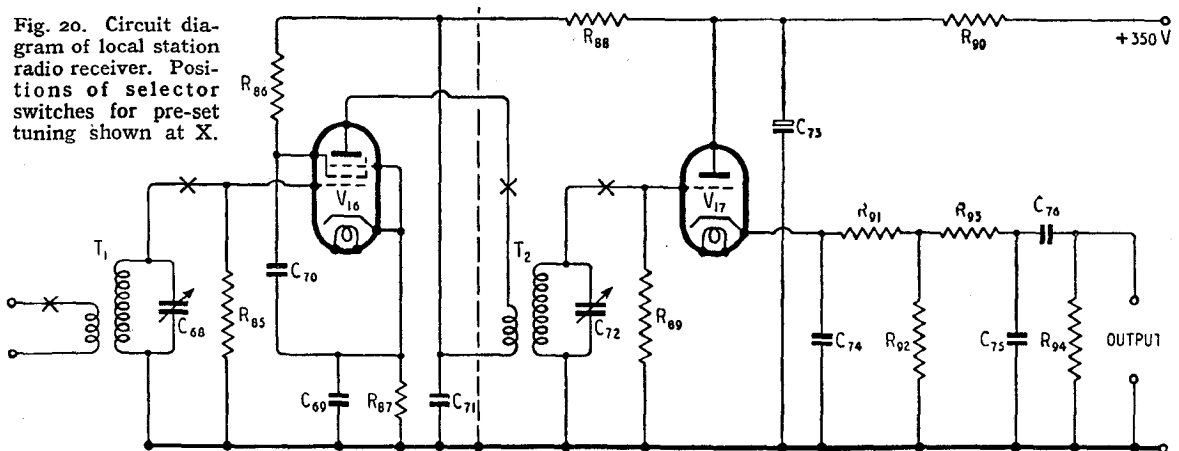

COMPONENT VALUES FOR CIRCUIT OF FIG. 20

	Rating	Type	Rating (V d.c. working)
R ₈₅	0.1 MΩ		
R ₈₆	0.1 MΩ		
R ₈₇	330 Ω		
R ₈₈	1.5 kΩ		
R ₈₉	0.1 MΩ		
R ₉₀	10 kΩ		
R ₉₁	47 kΩ		
R ₉₂	4.7 kΩ		
R ₉₃	22 kΩ		
R ₉₄	2.2 MΩ		
C _{68, 72}	See text		
C ₆₉	0.1 μF	Paper	250
C ₇₀	0.1 μF	Paper	350
C ₇₁	0.1 μF	Paper	350
C ₇₃	16 μF	Electrolytic	450
C ₇₄	100 pF	Silvered mica	
C ₇₅	100 pF	Silvered mica	
C ₇₆	0.1 μF	Paper	500

All resistors may be ½ W rating, tolerance 20 per cent unless otherwise specified.

VALVES.

V₁₆ Mullard EF39, Osram KTW61. V₁₇ Mullard EF37.

High-Quality Amplifier—

The basic circuit, shown in Fig. 20, consists of an r.f. amplifier, transformer-coupled to a negative-feedback detector. Circuit values for a number of alternative tuning arrangements are given. Possibly the simplest scheme, from the point of view of construction, is to use a twin-ganged capacitor to cover the range, although by this method it is not easy to secure a uniformly good performance at each end of the medium-wave band. Alternatively the receiver may be pre-tuned, stations being selected by a push-button or rotary switch. The use of variable inductors in this arrangement provides a simple method of achieving a uniform selectivity and sensitivity over the range, with the disadvantage that two coils or tuned circuits must be provided for each station to be received. In the unlikely event of serious thermal drift, correction is easily applied by the use of negative temperature coefficient capacitors.

R.F. Transformers.—Winding data are given to enable r.f. transformers to be wound simply on standard formers without the use of a wave-winding machine. The correct number of turns are piled in a random manner between thin Paxolin or cardboard cheeks, which serve to guide and support the edges of the winding. This gives an approximation to the performance of a wave-wound coil.

The table gives winding data for transformers to be used with a twin-ganged capacitor with a capacitance swing of 485 pF with trimmers, covering a frequency

WINDING DATA FOR R.F. TRANSFORMERS

Transformer	Winding	No. of turns	Inductance (μH)	Coefficient of coupling (approx.)
Aerial	Primary	35	30	0.35
	Secondary	95	160	
Coupling	Primary	60	80	0.65
	Secondary	95	160	

range of approximately 550-1,550 kc/s.

When separately-switched tuned transformers are to be used, the values of secondary inductance and tuning capacitance may be read from the curve of Fig. 21 against transmitter frequency. This curve has been computed for an L/C ratio of unity (L in μH , C in pF), which is nearly optimum. The number of turns necessary to produce the required inductance with the formers and dust-cores specified may then be obtained from Fig. 22. The dimensions of the coil formers and windings are shown in Fig. 23. When the capacitance is being chosen, allowance should be made for strays, which will probably be about 25 pF. The values used should therefore be less than those indicated by this amount. In practice the nearest standard value should be chosen, and allowance made in the value of inductance. Movement of the core will enable a variation of approxi-

mately ± 18 per cent to be made in the inductance.

Construction.—In order to preserve stability, precautions must be observed when constructing the receiver. The most likely cause of instability is the presence of undue stray capacitance between the anode and control grid of V_{16} . The valve types used have an anode-grid capacitance of less than 0.003 pF, and a layout should be chosen which does not materially increase this figure. The design, based on this value, has a factor of safety of about 4. Although the valve is metallized, a screening can may be necessary to reduce leakage to the valve base. All

Fig. 22. Curve relating inductance and number of turns for windings discussed in text.

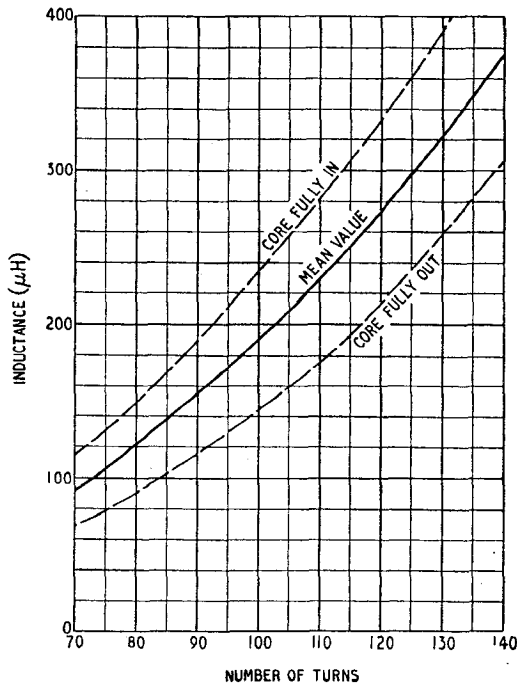
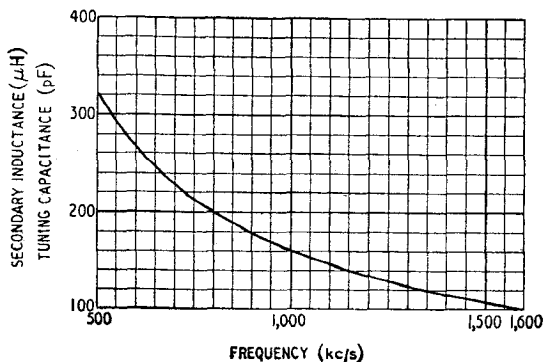
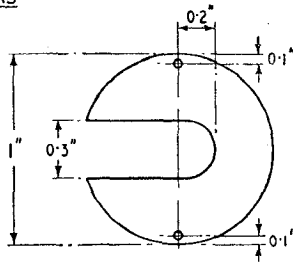
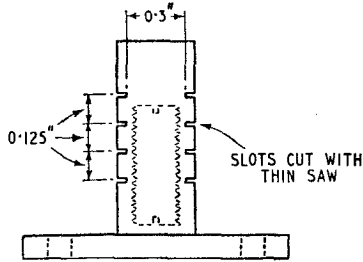

Fig. 21 (Below). Curve relating tuned circuit parameters and resonance frequency.



COIL FORMERS



MATERIAL; 0.015" BAKELIZED FABRIC OR PAXOLIN

AERIAL TRANSFORMER

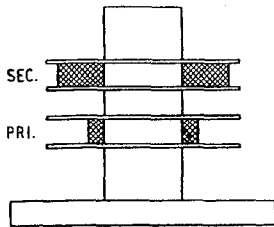

COUPLING TRANSFORMER

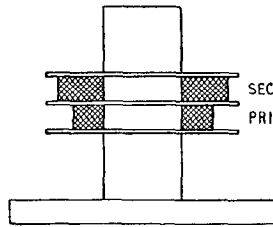

DATA FOR FIXED TUNING

PRIMARY WINDING. (DIRECT AERIAL CONNECTION)
 $\frac{1}{3}$ NUMBER OF SECONDARY TURNS

PRIMARY WINDING. (70Ω FEEDER)
 $\frac{1}{10}$ NUMBER OF SECONDARY TURNS

SECONDARY WINDING. SEE TEXT

PRIMARY WINDING.

$\frac{2}{3}$ NUMBER OF SECONDARY TURNS

SECONDARY WINDING. SEE TEXT

components in the grid circuit should be kept above the chassis, and all components in the anode circuit below the chassis. Where components in the anode circuit, or in the following grid circuit must be brought above the chassis, as is the case when tuning is by means of a ganged capacitor, they

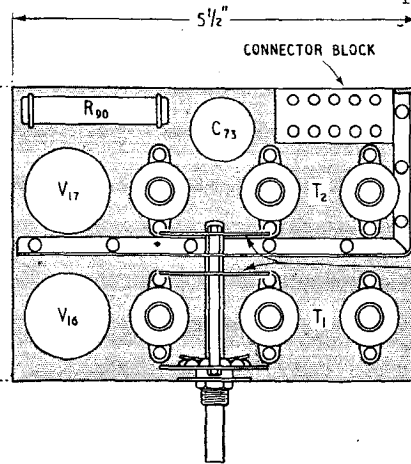
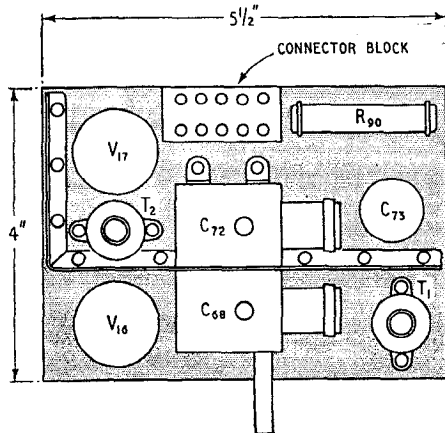

Fig. 25. Plan view of top of chassis. Switched model.

Power Supplies.—

The receiver is intended to be supplied from the pre-amplifier power supply. The decoupling is not adequate to

enable it to be fed from the main amplifier supply.

Acknowledgment. — The writer is indebted to Mr. A. T. Shepherd of Ferranti, Ltd., for his assistance in the compilation of data for these notes.

Note: In the list of components below Fig. 15, page 424, of the November issue, the value of R69 should be 1 MΩ, not 0.47 MΩ. C56 should be 0.5 μF, paper, 250 V d.c. working, ±20 per cent; C57, 50 μF, electrolytic, 12 V d.c. working, C64, 16 μF, electrolytic, 450 V working.

Fig. 23. Formers are standard moulded type, fitted with 8-mm threaded iron-dust cores. All coils are wound with Litz wire consisting of 7-9 strands of 45-48 s.w.g. enamelled copper wire.

must be screened carefully from the aerial circuits. Figs. 24 and 25 show suggested layouts for continuously variable and switched tuning arrangements.

The Detector.—To give low distortion, the detector requires to work at a fairly high signal level—say 5V r.m.s. output. As the receiver is intended to feed the tone compensation unit, which requires an input of only 200 mV peak, the output is taken from a tapping on the detector load resistance. This greatly reduces the a.c. loading on the detector and enables it to handle high modulation levels without distortion.

Alignment Procedure.—(1) Set ganged capacitor at a position about five degrees from the minimum capacitance end, and adjust trimmers for maximum output from the high-frequency 3rd Programme.

(2) Set capacitor about twenty degrees from maximum capacitance position and adjust dust-cores for maximum output from the low-frequency 3rd Programme.

(3) Repeat this process until both stations are accurately tuned.

TEST REPORT

EKCO MODEL CR61

All-wave Car Radio with Permeability Tuning

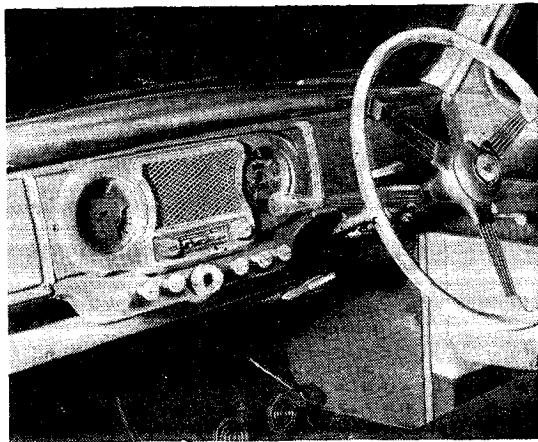

Ekco model CR61, all-wave set fitted in the Austin Hampshire saloon. The loudspeaker grille is immediately above the tuning head.

DESIGNED primarily for the overseas motorist this car radio receiver is an eight-valve superheterodyne possessing a number of quite unusual features. Not the least is the exceptional wide range of wavelengths it covers, not necessarily continuously since no useful purpose would be gained, but by a judicious selection of the principal broadcast bands a coverage of from 19 metres to 1,800 metres is provided. Reception on the long waveband is, however, limited to a single pre-set station, but the user can choose which station he prefers.

Bandspread

Tuning is not critical on any waveband, as the short wave ranges are, with one exception, restricted in coverage to a band of frequencies actually less than that on the normal medium waveband. Five free tuning ranges and four pre-set stations are selected by a nine-way rotary switch, which actuates a drum dial having the various ranges marked on it in megacycles as well as indicating which of the pre-set circuits are in use. The waveband table shows the sequence in which they appear, the ranges provided and their limits, also the actual coverage of each in kilocycles. The equivalent wavelengths in metres are included also.

While the three shortest wavebands have a very small coverage, the fourth, which is marked

"SW" on the dial, covers 40 to 90 metres (3.3 to 7.4 Mc/s) approximately. Broadcast stations are so widely scattered throughout this part of the short wave band that it would be extremely difficult, if not impossible, to select any one portion and bandspread it into a coverage of, say, 1,000 kc/s or less and take in all the stations likely to be required in various parts of the world.

Of the four pre-set positions one is for a long wave station and three are in the medium waveband. The positions on the dial are indicated in two ways; one is by an arrow-head pointing to a station name plate, the other by a small figure, 1 to 4 inclusive, which appears on the extreme right of the dial. These numbers correspond to similar numbers marked against the four pre-set adjustments on the receiver unit, being provided to act as a guide should it be required to change the pre-set stations at any time.

The equipment is divided into four main units, the receiver, power unit, tuning head and loudspeaker. The use of two, or more, loudspeakers is quite feasible with this receiver and, indeed, the makers actually recommend it where facilities allow as a speaker in the back of the car is a great boon to rear-seat passengers. The set is well able to take the extra load as it gives about 4 watts output.

The Circuit

The various units can be mounted separately or joined together to form a coherent whole of very compact form. When the items are separated it becomes necessary to mount the receiver and tuning head in reasonable juxtaposition as they are interconnected by shafts with flexible couplings. A considerable latitude is, however, possible in regard to their relative positions.

Eight valves of the latest all-glass type are used in the set which has an EAF42 r.f. amplifier, ECH42 frequency changer, EAF42 i.f. amplifier on 465 kc/s, and EAF42 functioning as detector, a.g.c. and first a.f. amplifier, EA50 noise limiter and a pair of EL42s in push-pull for the output stage. The eighth valve is an EZ41 rectifier which is in the

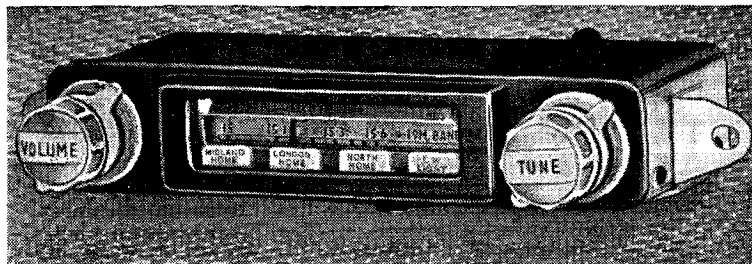

Close-up of the tuning head with the 19-m scale on the drum dial showing and below the four pre-set station name plates. Note the two sets of concentric controls.

power unit and provides h.t. in conjunction with a vibrator and transformer. The l.t. consumption is 3.4A at 12 volts. On a 6-volt supply it is 5.6A.

An interesting departure from the more orthodox practice is the use of permeability tuning for the variable, as well as for the pre-set, circuits. These are quite independent, being separate sub-assemblies and apart from other considerations the separate circuits help to lessen the risk of complete failure of the radio as it is possible for a defect to appear in one unit without putting the set entirely out of action. Either free tuning or pre-set operation would be available.

Permeability Tuning

The free tuning system consists of six coils mounted in a screening box with six dust iron cores mounted on a carrier driven by a spindle, which is linked by shaft and flexible coupler to the tuning knob on the remote control unit. These six coils form the primary tuning elements of the receiver. One set of three is for medium wave tuning of the r.f., f.c., and oscillator, the remaining three being brought into circuit by the waveband switch initially for the 40- to 90-metre band (3.3 to 7.4 Mc/s) and subsequently as the tuning system for all the other short wave bands. As the switch is moved from one short wave position to another it switches loading coils in parallel with these primary circuits and as the variable elements of the tuned circuits are a part only of the total circuit inductances the coverages on the 19-m, 25-m and 31-m bands are restricted to the amounts given in the table.

Orthodox practice is adopted for the i.f. and noise limiter stages and these need no comment. A combined diode and r.f. pentode valve is unusual for the detector and first a.f. stage, but as a.g.c. is applied to the pentode portion a valve with variable-mu characteristics is needed.

Resistance-capacitance coupling links the a.f. amplifier with the push-pull output stage and an interesting feature of this part of the circuit is that one of the push-pull valves serves as a phase inverter for the other. A resistor of

WAVEBAND TABLES

Waveband	Frequency limits	Wavelength (approx.)	Coverage
19-metre	15.0 to 15.6 Mc/s	20 to 19.2 met.	600 kc/s
25-metre	11.6 to 12.3 Mc/s	25.8 to 24.4 met.	900 kc/s
31-metre	9.3 to 10.1 Mc/s	32.3 to 29.7 met.	800 kc/s
sw band	3.3 to 7.4 Mc/s	91 to 40.6 met.	4,100 kc/s
med. waveband	515 to 1,640 kc/s	583 to 183 met.	1,125 kc/s
Pre-set 1	1,000 to 1,540 kc/s		
Pre-set 2	790 to 1,220 kc/s		
Pre-set 3	550 to 880 kc/s		
Pre-set 4	167 to 245 kc/s		

1.8kΩ is included in the screen grid supply to one of the valves and this electrode is coupled via a 0.01-μF capacitor, to the input grid of the second push-pull valve. Signal voltages on the screen grid of the first valve being of opposite phase to those on its input grid gives the necessary phase inversion and it is only necessary to select component values that provide the required amplitude of signal to preserve the balance in the stage.

Tone Control

Another interesting feature is the tone control system which is obtained by modifying the negative feedback circuit linking the anode of one output valve to the anode of the first a.f. amplifier.

Normally there is a fixed

amount of feedback via a 3.3 MΩ resistor and this is augmented by extra feedback applied over a frequency discriminating network that favours the upper register. A simple three-way switch, located in the tuning head, controls the amount fed back over this network.

In general a preponderance of treble is not unwelcome in a car as the rather confined space is inclined to over-emphasize the low notes. Possibly opinions will differ on this matter, but the range of control provided is quite sufficient to satisfy all tastes.

The road test was made with a CR61 fitted in an Austin A70 Hampshire saloon. As shown in the illustration the tuning head and loudspeaker form an integral part of the instrument panel as in

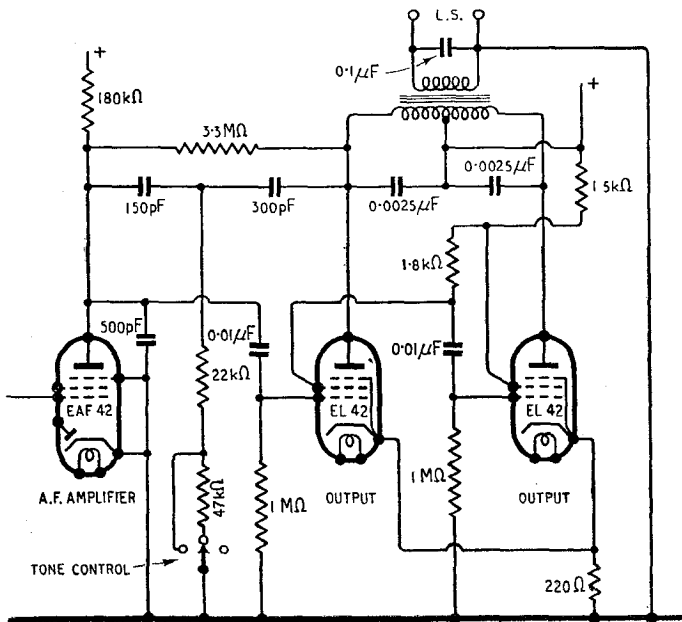

Phase inverting output stage with negative feedback tone control used in the CR61 receiver.

Ekco Model CR61—

this case the fitting was carried out on the Austin production line. A telescopic aerial is mounted in an insulating bush just ahead of the near-side front screen pillar, its position being such that it is almost invisible from the driving seat and does not interrupt the view of the road.

On each side of the scale window in the tuning head are two concentric controls, the outer one on the right being for free tuning and its inner one is the three-position tone control. Of the left-hand pair the outer is a combined volume control and on-off switch, while its companion is the waveband switch.

Concentric controls are often a little awkward to manipulate unless one is very much larger than the other, but in this set the problem has been tackled in two ways. First, the inner controls are slightly larger, and secondly, they have two ears, which not only assist their operation but makes them easily distinguishable by feel, and is a great advantage for night driving.

As the suppression of interference is now well understood it is, perhaps, redundant to comment on the absence of interference by the ignition and the electrical accessory circuits. If the receiver be tuned to a blank spot on the dial then a faint background of engine noise is discernible and it

is just possible to hear the screen-wiper motor.

At times a little interference was noticed from passing lorries, buses and tramway cars, but in general, private cars caused surprisingly little interference. It may be that many private owners have fitted suppressors, but there is also the possibility that the anti-interference filters used in the CR61 contribute more than is realized to the suppression of interference picked up by the aerial.

Performance

Sensitivity and selectivity of the receiver are more than adequate for all normal requirements. On the road between London and the South Coast the main B.B.C.'s medium-wave stations were received with volume to spare, the Midland station, for example, providing an exceptionally good signal. The Light programme on 1,149 kc/s, which is often a little elusive on the South Coast at sea level, was received at good strength at all hours.

In the dense traffic of London Continental stations were well in evidence, but away from the Metropolis, especially on high ground, they were almost predominant. Judged on this basis there should be no difficulty in receiving the B.B.C.'s medium-wave stations almost anywhere on the Continent.

Turning to the short waves, all

four bands provided a plethora of signals, and the difficulty was not finding something to listen to, but in identifying those that were receivable.

On these bands the effect of fading began to be noticed, but through no defect in the a.g.c. system, which behaved as well as could be expected in the circumstances. A.g.c. is impotent when signals fade to almost inaudibility, but it did operate very well indeed on the rapid "flutter" type of fading encountered on the short waves. The flutter was, of course, audible by rise and fall of background noise, but taken by and large the signal remained reasonably steady.

The action of a.g.c. often became apparent on medium-wave stations when passing under bridges, between tall buildings and through avenues of trees, but during the whole of the test no single instance was recorded when a signal, normally of good programme value, was lost due to inadequate sensitivity or a.g.c. action.

Not the least important of the short-wave performance was the steadiness of the local oscillator after the receiver had reached its normal operating temperature. The bandspread tuning on the three shortest ranges undoubtedly contributes largely to the absence of drift, but even on the non-bandspread range of 3.3 to 7.4 Mc/s very little adjustment to tuning was needed. Incidentally, broadcast is not the only form of entertainment this Ekco set provides, as, if one's inclination leans towards amateur radio, the 3.3-7.4 Mc/s range offers a little diversion. On one occasion on the South Coast we overheard a two-way contact between a London and a Manchester amateur on the 40-metre band, both stations being strong enough to need toning down a little with the volume control.

The Ekco CR61 all-wave car radio receiver is, with good justification, termed a "luxury" model by the makers (E. K. Cole, Ltd., Southend-on-Sea, Essex). It is intended especially, though not exclusively, for the overseas motorist. The price of the set is £34 13s (exclusive of accessories), plus £7 10s 2d purchase tax on home sales.

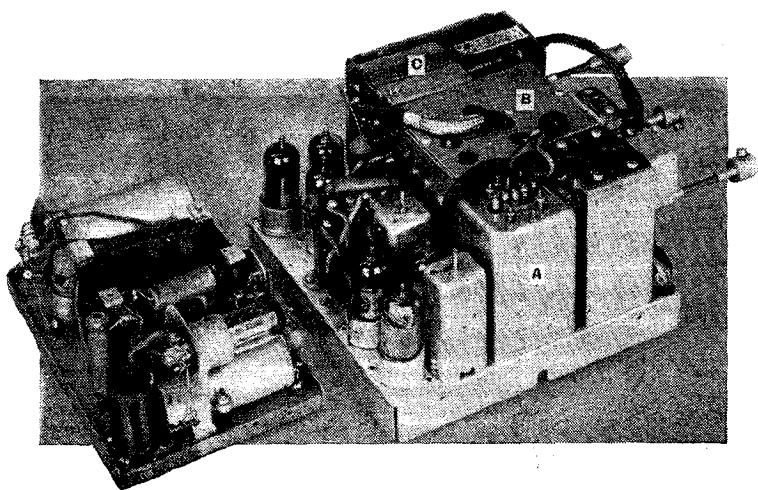

Receiver and power units removed from their cases. The pre-set tuning coils (A), waveband switching and loading coils (B) and the primary tuning circuit (C) are contained in separate sub-assemblies on the receiver chassis.

THE "BELLING-LEE" PAGE

Providing technical information, service and advice in relation to our products and the suppression of electrical interference

Radiolympia Notes, Prices, etc.

The public and trade demonstrated their confidence and interest in "Belling-Lee" aerials at Radiolympia by continually surrounding our stand and we have learnt a great deal from their questions; number one outstanding item that is called to mind is the agreeable surprise registered by many visitors on hearing (a) the prices of aerials and (b) the cost of installations. Most of the people to whom the writer spoke, expected

higher prices. Number two is the interest in "fringe area" reception, and a surprising number of people think ten guineas plus the cost of a pole and erection is a very reasonable

price to ask for a "Multirod"*1 to give best possible reception in "fringe areas." We expected to sell a few to enthusiasts, but when fifty were sold before lunch on the opening day of the exhibition and about a hundred a day afterwards we have had to change our production arrangements.

Disputes between Landlord and Tenant over aerials.

Many visitors complained of their inability to erect outside aerials through lack of agreement with their landlords. This is an unfair restriction, and usually arises from lack of accurate information on the part of the landlord; concerted action is being taken. If any readers are in this difficulty, do please write and give us the circumstances, when every possible step will be taken to present a true and unbiased statement to the landlord.

When the location is within eight to ten miles of a transmitter and interference is not severe it is likely that either a "Veerod," "Doorod" or "Viewflex"*2 will serve adequately. All these are indoor types.

Unsuitable aerial recommendations.

We have recorded some black marks; one is, a customer who lives within two miles of Alexandra Palace and whose dealer refused to guarantee satisfaction unless an "H" type "Viewrod" was installed; aerial plus installation costing twelve pounds. The customer was swamped with signal and had to be told to go back to the dealer and ask that an attenuator be fitted. Such an erection could only be justified if there was some **extraordinarily virulent** interference behind the aerial and in a straight line with the transmitter. Another is when a dealer was stated to have fitted "Doorods" by the "dozen" eight to ten miles from the transmitter, apparently without due regard to peculiarities of individual locations. This is unfair to the "Doorod," nor is the dealer being fair to his own reputation or to the receiver manufacturer. When asked if one could guarantee a "Doorod" or "Viewflex" within a few miles of a transmitter our general reply was that we could guarantee to position **any indoor aerial** (in relation to pipework, etc.) so that **little or no signal** could be picked up, but that these aerials should give every satisfaction if carefully sited and where interference is not too severe.

Suppression and indoor broadcast aerials.

Many questions were asked about suppression; the first reply invariably went back in the form of another question; what aerial is being used? It is rarely worthwhile doing much about suppression unless at least part of the aerial is outside and standing away from the house. Such aerials are the "Winrod" and "Twinrod"*3. It is not much use fitting a set lead suppressor when the only aerial is round the picture rail or under the carpet.

The Post Office Exhibit.

We are indebted to the General Post Office for telling our story so very much better than we could ourselves. Of course we are "shareholders" and they are always most co-operative. We were particularly impressed by their model house, and by their demonstration of suppression of interference from motor car ignition systems. The motor car is the one really severe form of interference that is everywhere spoiling television, and actually hindering the sale of television receivers in towns over thirty miles from a transmitter. The trouble can be cured in 97 per cent of cases (independent statistics) for 1/6 per car.

Motor ignition interference.

Surely your neighbours and tradesmen with vans would co-operate. It does not take a minute and does not affect the engine. A car with car radio has already been treated, so this covers most police cars, and army fighting vehicles.

Many public utility services and operators of large fleets of vehicles are co-operating. Are your local taxis suppressed? If you have neighbours with un-suppressed motor cars, you can obtain from us, or from the Television Society a few "courtesy" leaflets for distribution among them explaining the matter. It might be well worthwhile. The suppressors are usually obtainable from your radio dealer or garage.

Types and Prices

*1 "Multirod" with 9ft mast.
£10/10/-. See illustration.

*2 "Veerod" attic aerial, 25/-.

Twin. Coax.

"Doorod" indoor
T.V. aerial .. 26/6 30/-

"Viewflex" all flex-
ible dipole .. 17/6 21/-

*3 "Twinrod" dual
purpose aerial .. 29/- 32/6

Registration and patents applied for.

BELLING & LEE LTD
CAMBRIDGE ARTERIAL RD., ENFIELD, MIDD., ENGLAND

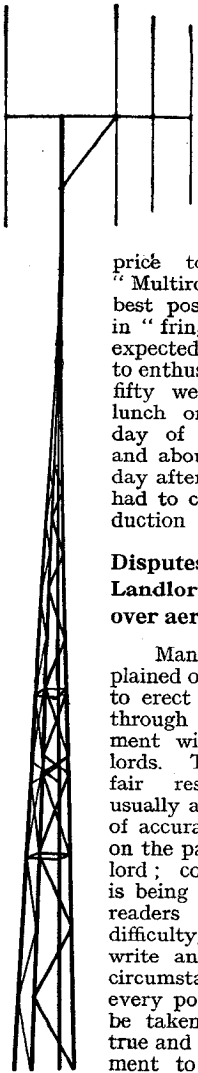



Stentorian

CONCENTRIC DUPLEX

A new quality speaker for the enthusiast

This twin "quality" reproducer, incorporating two independent speakers, is the latest application of the now well-known 'Series gap' magnet system, originated by W.B. engineers.

The centre pole is hollow, and forms the beginning of the pressure horn which loads the convex high-frequency diaphragm at the rear. In front this pole piece is surrounded by a separate gap, in which the low-frequency speech coil operates. The speaker should not be confused with the double-cone type.

There is no cross modulation, and the range very evenly covered (especially if a crossover network is used) is from 50 to 14,000 c.p.s.

Although suitable for outputs up to 6 watts only, this small speaker is nevertheless a high-fidelity reproducer in the best sense of the word. You should try it.

PRICE £6-6-0

complete with matching transformer and filter condenser.

Mounted in de luxe table cabinet - - - - £11-3-0
 Corner console twin speaker, less transformer - - £12-12-0

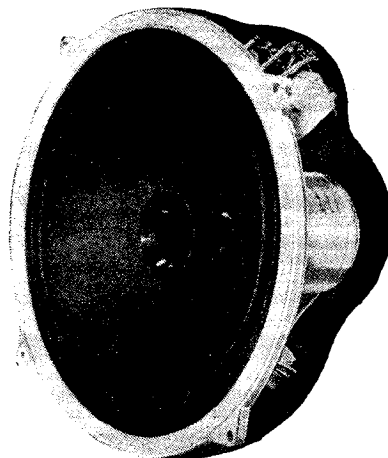

SPECIFICATION

Series Gap Magnet of Alcomax 3.
 Cone: 10" diameter.
 Flux in L.F. gap, 12,000 gauss on 1" pole.
 Flux in H.F. gap, 13,000 gauss on 1" pole.
 Power handling capacity (both component speakers) 6 watts.
 Chassis material pressure die-cast from Mazak 3, non-magnetic and non-resonant alloy.

WHITELEY ELECTRICAL RADIO CO. LTD · MANSFIELD · NOTTS

G.E.C. QUARTZ CRYSTAL UNITS

For Reliable Radio Communications

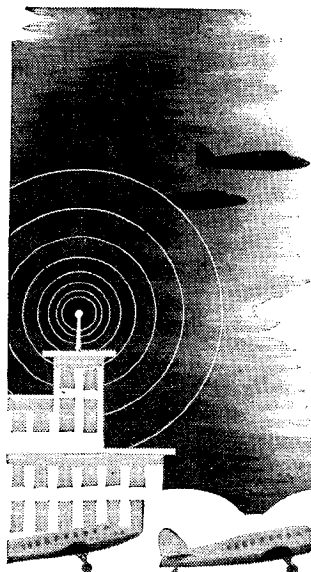

From take-off to landing, the safety of passengers, cargo and machines is largely dependent on trouble-free radio communication.

Weather reports, conditions at terminal airports etc., must be reported to aircrews.

Navigation by radio beacons plays an important part in keeping the planes flying safely on their assigned routes.

Be sure, then, that the Quartz Crystal Units in your radio equipment are the best obtainable, for they are the most critical components.

Pioneering research and experience in making over a million units, ensure a product of the finest available quality at competitive prices. We can give rapid delivery for your urgent requirements.

When the requirement is exceptionally urgent, phone Middleton (Lancs.) 2424 or Temple Bar 4669 (London).

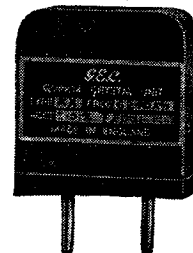

SALFORD ELECTRICAL INSTRUMENTS LTD. PEEL WORKS · SILK ST. SALFORD 3 · LANCs.

A Subsidiary of THE GENERAL ELECTRIC CO. LTD. OF ENGLAND

WORLD OF WIRELESS

New Television Advisers ♦ Aircraft Radiotelephony ♦ Amateur Show ♦ Television Servicing Certificate

Television Committee

IT was announced by the P.M.G., in reply to a question in the House on November 2nd, that the Television Advisory Committee had been reconstituted. He stated that, in view of the appointment of the Broadcasting Committee, under the chairmanship of Lord Beveridge, which was considering the wider aspects of broadcasting (including television), it had been decided to alter the Advisory Committee's terms of reference to "advise the Postmaster-General on current development problems of the B.B.C.'s television service."

In addition to Sir William Coates, who was recently appointed chairman, the membership of the Advisory Committee includes I. A. R. Stedeford, who is also a member of the Broadcasting Committee; Professor J. A. Ratcliffe, of Cavendish Laboratory; H. Townsend, Director of Telecommunications, G.P.O.; Sir William Haley, Director-General, B.B.C.; and an official of the Treasury. The secretary, H. Baker (G.P.O.), is also assistant secretary of the Broadcasting Committee.

Some misgivings have been voiced by the Radio Industry Council at the curtailing of the terms of reference, which were previously very wide. It has, however, been pointed out that complete liaison is being maintained between the two committees, and, moreover, that whereas the Beveridge committee will consider the long-term policies, the Coates committee will deal with current developments.

Civil Aviation Radio

THE Ministry of Civil Aviation recently introduced a v.h.f. radio-telephony system providing continuous coverage for all aircraft flying on the routes between Aberdeen and the Shetlands. The system, which employs seven stations, is designed to give coverage along the whole route. D.F. is provided on the communication frequencies.

This is the first part of a project to cover the whole of the British Isles with v.h.f. radio-telephony and direction finding. The intention is that this will supersede the existing system of m.f. and h.f. morse communication and direction finding.

The introduction of this plan will mean a reduction in the amount of equipment carried by aircraft flying on internal routes.

The plan provides for transmitters and receivers strategically located on high ground throughout Great Britain and part of Northern Ireland. The transmitters, operating on the multi-carrier principle, will be modulated from Air Traffic Control centres at Uxbridge; Barton Hill, near Preston; and Prestwick. The receiver outputs will, of course, be fed to the same centres.

Amateur Exhibition

THE third annual amateur radio exhibition, organized by the Radio Society of Great Britain, is being held at the Royal Hotel, Woburn Place, London, W.C.1, for four days from November 23rd. Admission to the show, which is open daily from 11 a.m. to 9 p.m., is by catalogue, price 1s.

The 24 exhibitors include the G.P.O. Engineering Department and the Air Ministry; eighteen manufacturers and four publishers. The manufacturers include Standard, Webb's, Quartz Crystal, Radiocraft, Oliver Pell, T. C. C. Philpott's Metalworks, Salford, Denco, Taylor, Cyril French, Imhof, Automatic Coil Winder, Southern Radio, Sangamo Weston, G.E.C., Woden and E.M.I.

We hope to give a review of the exhibits in our next issue.

Television Servicing

THE first examination for the Television Servicing Certificate, organized jointly by the Radio Trades Examination Board and the City & Guilds of London Institute, will be held on May 2nd and 4th

next year. The practical examination will be held at a later date. As London will be the only centre, it may be necessary to restrict the number of entries.

Admission to the examination is limited to candidates who have passed one of the following examinations:—

(a) The Radio Servicing Certificate Examination held jointly by the City & Guilds and the R.T.E.B.

(b) The Radio Servicing Examination held by the R.T.E.B. from 1944 to 1946.

(c) The examination in Radio Service Work of the City & Guilds held from 1938 to 1947.

(d) The "third year" examination in Radio Service Work of the Union of Lancashire and Cheshire Institutes.

(e) The examination in Radio Servicing held prior to 1944 by the Brit. I.R.E.

(f) The examination in Radio Servicing held prior to 1944 by the Scottish Radio Retailers' Association.

Regulations and entry forms are obtainable from the secretary of the R.T.E.B., 9, Bedford Square, London, W.C.1. The closing date for entries is December 15th.

PERSONALITIES

Sir Edward Appleton, until recently Secretary of the D.S.I.R. and now Principal and Vice-Chancellor of Edinburgh University, is to receive the honorary degree of Doctor of Laws from London University. From 1924 to 1936 Sir Edward was Wheatstone Professor of Physics at the University.

R. C. Wansbrough, M.A., M.I.E.E., M.Brit.I.R.E., who has been appointed personal assistant to E. J. Emery, managing director of E.M.I. Sales and Service, Ltd., recently retired from the R.A.F. with the rank of Air Commodore. Among the positions he held during his 30-odd years' service in the R.A.F. were those of Deputy Director of Radio Repairs (M.A.R.) and Director of Radio at the Air Ministry.

L. H. Bedford, O.B.E., M.A., B.Sc. (Eng.), of Marconi's, was elected president of the British Institution of Radio Engineers for a second year at the recent annual general meeting.

UN - RETOUCHE
picture taken directly from the screen of a *Wireless World* superhet television receiver at Bath, some 100 miles from Alexandra Palace.



World of Wireless—

Paul Adorian, a director of Redifon, and W. E. Miller, M.A., Editor of *The Wireless and Electrical Trader*, were re-elected vice-presidents.

L. Hotine, who joined the B.B.C. in 1923 and has been Senior Superintendent Engineer since 1943, has been placed in charge of that section of the Operations and Maintenance Dept. of the B.B.C. Engineering Division which consists of the studio, transmitter, recording and lines departments.

M. J. L. Pulling, M.A., M.I.E.E., has been appointed Senior Superintendent Engineer (Television) to take charge of the television side of the B.B.C. Engineering Division's work. He joined the Corporation in 1934 and became Superintendent Engineer (Recording) in 1941. He is a vice-president of the British Sound Recording Association. D. C. Birkinshaw, M.B.E., M.A., M.I.E.E., will continue as Superintendent Engineer (Television), to which post he was appointed in 1945 after 13 years' service with the Corporation. During the war he was engineer-in-charge of the Daventry short-wave station, prior to which he held a similar position at the London television station.

Harry A. Woodyer, who was until recently sales manager of Kolectric, Ltd., has been appointed managing director. He has been in radio for over 26 years, having been on the staffs of Dubilier and T.M.C., and from 1940 to 1946 was radio sales manager of Simmonds Aerocessories.

OBITUARY

Walter G. Pye, who founded in 1899 the company of Cambridge instrument manufacturers bearing his name, died recently at the age of 80. He worked in the Cavendish Laboratory, Cambridge, prior to setting up in business. When W. G. Pye and Co. started manufacturing broadcast receivers, Pye, Ltd., was formed to develop this side of the business.

IN BRIEF

Licences.—With increases of 65,250 and 8,850 sound and vision licences, respectively, during September, the totals at the end of the month were sound 11,920,600 and vision 171,000.

Amateur Television.—The Radio Society of Great Britain has asked the Postmaster-General for permission for selected amateurs to use television transmitting equipment within certain sections of the 420-Mc/s amateur band. The request has been refused.

For the Blind.—A Braille edition of the "Admiralty Radio Handbook" is in course of preparation by the National Institute for the Blind which, when completed, will comprise 18 volumes. It is also recorded in the annual report of the Institute that since its commencement in 1929 the "Wireless For The Blind Fund" has supplied 84,887 free sets. During last year 4,065 sets and relay installations were supplied. The response to last year's Christmas Day broadcast appeal was £30,596.

Amateur Power.—The Postmaster-General has granted permission for U.K. amateurs, other than those holding licences limiting power to 10 and 25 watts, to use a power of 150 watts on all amateur frequency bands above 28 Mc/s with the exception of the 420-460-Mc/s band on which the limit remains at 25 watts. The concession is for an experimental period of one year from October 18th.

R.E.C.M.F. Exhibition.—The ballot for stands at the exhibition of components, valves and test equipment, to be held at Grosvenor House, Park Lane, London, W.1, from April 17th to 19th next year was held on October 26th. There were nearly 100 applicants for space at this, the seventh show to be organized by the Radio and Electronic Component Manufacturers' Federation.

Antarctic D.F.—The two aircraft to be used to reconnoitre the ice fields and to guide the Anglo-Scandinavian Antarctic Expedition ship *Norsel* through them will be equipped with Marconi Type AD7002 automatic direction finders for guiding them back to the ship after reconnaissance. These have been fitted to obviate the errors which may be introduced in the planes' magnetic compasses when flying within the magnetic influence of the South Pole.

Marconi marine radar equipment, Radiolocator III, has been given the Ministry of Transport's "type approval" certificate which is granted after tests conducted to ensure efficiency, mechanical sturdiness and conformity with the M.O.T. specification.

A Student's Guide to the courses of study in engineering available in the Manchester district is published by the Manchester and District Advisory Council for Further Education. Particulars are obtainable from the Education Officer, Deansgate, Manchester, 3.

Colour Television.—At a meeting of the Institution of Electrical Engineers on October 31st, Dr. P. C. Goldmark gave a lecture on "The C.B.S. Colour Television System in the U.S.A." After dealing with the general history of colour television, Dr. Goldmark discussed the requirements of illumination, the choice of primary colours, and colour flicker. A demonstration of Pye three-colour television equipment, which is similar to the C.B.S. system, was given.

"**Radio Data Charts,**" which gives in graphical form most of the essential data for the design of receivers, has been revised and is again available from booksellers, price 7s 6d, or by post from our Publisher, price 7s 10d.

"**B.B.C. Year Book.**"—The 1950 edition of this annual contains the usual wealth of information on the B.B.C. activities and an extensive reference section. This copiously illustrated 176-page book, costs 3s 6d.

Plastics.—In the book "Experimental Plastics for Students," by C. A. Redfarn and A. Allcott, published for *British Plastics* by our Publisher (price 10s 6d), thirty-four experiments are described to give readers an appreciation of the principles involved in the production and moulding of plastic materials.

EXPORTS

Radio-Telephony in S.A.—A u.h.f. radio-telephony link has been installed by Standard Telephones and Cables for the South African Post Office to extend communications between Port Elizabeth and Uitenhage—a distance of about fifteen miles. Half-wave dipoles (with directors) with corner reflectors are used at both stations. The "Standard" time-sharing multiplex system has been used which provides 24 channels and allows direct dialling between the telephone exchanges.



MAGNIFICATION of dental operations to eight times life size were given, with the aid of Marconi portable television equipment working on a closed circuit with monitors in the lecture theatre, to those attending a recent function at the Royal Dental Hospital, London.

Marconi Demonstrations.—A week of demonstrations of television test equipment is being held by Marconi Instruments at their showrooms, 19, The Parade, Leamington Spa. During the week, which ends on November 26th, demonstrations are also being given by Marconi's W.T. Co. of a complete portable television camera chain. The showrooms are open from 10 a.m. to 5 p.m.

Brazil.—Tenders are being sought by the Rio Grande do Sul State Commission for Electric Energy for wired-wireless equipment, for use on the high-tension cables to provide a communication system between the main generating stations and the substations. The frequency to be used on the 66 kV lines will be between 90 and 150 kc/s. The audio-frequency equipment includes 50 telephones. A

copy of the specification (in Spanish), Ref. CRE(IB) 31194/49, is available at the Commercial Relations and Exports Department, Board of Trade, Room 1080, Thames House North, Millbank, London, S.W.1, from whom further information is obtainable.

Pye Television is to make its debut in the United States. A complete transmitter, including cameras and monitoring equipment, for operation on the American 525-line standard has been shipped to the U.S. and is to be set up for demonstrations in Washington, New York and Chicago. The whole of the equipment is transportable in suitcase-size containers.

C. G. ALLEN, a director of McMichael's and a well-known amateur, was recently filmed talking to Henry Rieder, a South African amateur who frequently receives the London television transmissions. The film was televised and here is the un-retouched picture as received on the screen of a McMichael set.

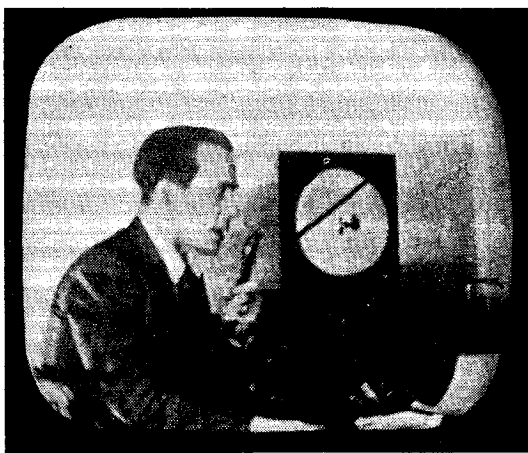

B.E.A.M.A. Catalogue.—The first (1949/50) edition of this 868-page catalogue of the products of members of the British Electrical and Allied Manufacturers' Association has been issued by our Publisher for B.E.A.M.A. Thirteen thousand copies have been printed, ten thousand of which are being distributed overseas. The catalogue section, consisting of 740 pages, is printed in three colours. The buyers' guide and directory of addresses includes over ten thousand entries.

Marconi Instruments.—Two members of the staff of Marconi Instruments, Ltd., F. G. Cook, manager, instrumentation exports, and E. Garthwaite, development manager, are paying a six-weeks' visit to the United States to explore the possibilities of marketing Marconi test and measuring gear.

Falkland Islands.—An order for forty fixed-frequency transmitter-receivers to supplement the existing inter-island line communication system is to be supplied to the Falkland Islands authorities by Berry's (Short-Wave), Ltd.

Decca.—*Navigator*, the demonstration vessel of the Decca Navigator Co., has sailed for Holland and Belgium to demonstrate Decca radar equipment in those countries.

CHANGES OF ADDRESS

International Aeradio, Ltd., has moved its head office to Aeradio House, 40, Parker Street, London, W.1 (Tel.: Regent 5024). A subsidiary of the company has been formed in Karachi with the title International

Aeradio (Pakistan), Ltd. Technical training of aviation staff is being undertaken by the company on behalf of the Pakistan Government.

Londex.—Additional premises close to their present works at 207, Anerley Road, London, S.E.20, have been acquired by Londex, Ltd., manufacturers of remote-control equipment.

Kolectric, Ltd., manufacturers of coil-winding machines, have opened offices and showrooms at 73, Uxbridge Road, London, W.5 (Tel.: Ealing 9096). All correspondence should now be sent to this address and not to the works at Grove Hill, Beverley, E. Yorks.

MEETINGS

Institution of Electrical Engineers

Radio Section.—"Solar Radio-Frequency Radiation," by J. L. Pawsey, M.Sc., Ph.D., at 5.30 on December 7th.

"The Acoustics of Studios and Auditoria," by W. Allen, at 5.30 on December 19th.

Discussion Circle.—"The Electron Theory Approach to Electro-magnetism," discussion opened by Prof. J. Thompson, D.Sc., M.A., at 6.0 on November 29th.

The above meetings will be held at the I.E.E., Savoy Place, London, W.C.2.

Cambridge Radio Group.—Address by R. T. B. Wynn, C.B.E., M.A., chairman of the Radio Section, at 6.0 on December 13th, at the Cambridge-shire Technical College.

North-Western Centre.—"Some Electromagnetic Problems," by Prof. G. W. O. Howe, D.Sc., LL.D., at 6.15 on December 6th, at the Engineers' Club, Albert Square, Manchester.

North Lancashire Sub-Centre.—"Some Electromagnetic Problems," by Prof. G. W. O. Howe, D.Sc., LL.D., at 7.0 on December 7th, at the North-Western Electricity Board Demonstration Theatre, North Road, Lancaster.

South Midland Centre.—Faraday lecture on "Radar," by R. A. Smith, M.A., Ph.D., at 6.0 on December 5th, at the Town Hall, Birmingham.

South Midland Radio Group.—"The Observation of Ionospheric Interaction," by D. A. Bell, M.A., B.Sc., F. J. Hyde, B.Sc., and C. C. Newton, at 6.0 on November 28th, at the James Watt Memorial Institute, Great Charles Street, Birmingham.

British Institution of Radio Engineers

London Section.—"Electronics in Aircraft Design," by A. L. Whitwell, at 6.30 on December 15th, at the London School of Hygiene, Gower Street, W.C.1.

Merseyside Section.—"The Acceleration of Atomic Particles to High Energies," by J. D. Craggs, M.Sc., Ph.D., at 7.0 on December 7th, at the Accountants' Hall, Derby Square, Liverpool.

North-Eastern Section.—"A Review of the Basis of Electronics," by C. Laverick, at 6.0 on December 21st, at Neville Hall, Westgate Road, Newcastle-on-Tyne.

Scottish Section.—"Electronics in Industry," by A. A. M. Turnbull, at 6.30 on December 1st, in the Electrical Department, Glasgow University.

South Midlands Section.—"H.T. Supply for High Power Transmitters," by M. Lane, at 7.0 on December 15th, at the Technical College, The Butts, Coventry.

British Sound Recording Association

London.—"Some Aspects of L.F. Performance of Loudspeakers," by G. A. Briggs, at 7.0 on November 25th at the Royal Society of Arts, John Adam Street, W.C.2.

"Acoustics and the Film," by C. W. Glover and John McLaren, at 7.15 on December 7th at the G.B. Theatre, Film House, Wardour Street, London, W.1. (Joint meeting with the British Kinematograph Society.)

Birmingham.—Dr. L. E. C. Hughes will address a meeting at 2.15 on November 26th at the Imperial Hotel, Temple Street.

Institute of Navigation

"Navigational Systems and Instrumental Aids," by Dr. D. E. Adams and Dr. A. N. Uttley, at 6.0 on December 15th, at the Institution of Civil Engineers, Great George Street, London, S.W.1. (Joint meeting with the Royal Aeronautical Society.)

"Radar Charts," discussion opened by Lt. Cdr. P. G. Satow, D.S.C., R.N., on the adaptation of marine charts for use with radar, at 5.0 on December 16th, at the Royal Geographical Society, 1 Kensington Gore, London, S.W.7.

Institute of Physics

Electronics Group.—"The Nervous System as an Electrical Machine," by Dr. W. Grey Walter at 5.30 on December 13th, at the Institute's House, 47 Belgrave Square, London, S.W.1.

Radio Society of Great Britain

Annual general meeting at 6.30 on December 16th, at the I.E.E., Savoy Place, London, W.C.2.

Television Society

Constructors' Group.—"Baird Television Receivers," by P. Wigley, B.Sc., at 7.0 on December 8th, at the Cinema Exhibitors' Association, 164 Shaftesbury Avenue, London, W.C.2.

Bedford Centre.—"Television Aerial Problems," by E. M. Lee at 7.30 on December 14th, at the Flying Services Club, St. Mary's Street, Bedford.

Bristol and S.W. Centre.—"Television Aerials and Interference Problems," by E. M. Lee, on December 6th at the Royal Hotel, Bristol.

Guild of Radio Service Engineers

Edinburgh Branch.—"Radio Capacitors," by a member of T.C.C. staff, at 7.30 on December 15th, at Unity House, 4, Hillside Crescent, Edinburgh.

ELECTRONIC DIVERSITY SWITCHING

(Concluded from Page 418 of November issue)

Design and Operation of Triple Diversity System

By **H. V. GRIFFITHS**
and **R. W. BAYLIFF**

(Engineering Division, B.B.C.)

IN the first part of this article the advantages of switched over combined - output methods in diversity reception were discussed, and an electronic switch for two receiving circuits was described. We shall now consider the extension of the method to three circuits.

Fig. 3 shows the full schematic of the triple-diversity version of the switch. It will be seen that three triode-hexode valves, instead of two, are used in the gate. Otherwise this part of the circuit

is identical with that used in the dual switch.

The discriminator contains duplicate circuits of the type used in the dual switch, together with additional circuits which interpret and rearrange the switching voltages developed by the four valves V_1, V_2, V_6 and V_6 . The three a.f.

signals from the diversity receivers are introduced into the three input channels, and the negative control potentials, E_1, E_2 and E_3 , are separated by the centre-tapped resistor combinations $R_{35}-R_{36}, R_{45}-R_{46}$, and $R_{50}-R_{51}$. E_1 and E_2 are applied through the cathode followers V_{10a} and V_{10b} to the first pair of discriminator valves, V_1 and V_2 . E_3 is similarly applied, through the cathode follower V_{11} to V_5 , the first of the second pair of discriminator valves. V_6 derives its control potential from

Values of Components used in Circuit of Fig. 3.

Component	Value	Rating	Component	Value	Rating	Component	Value	Rating
R ₁	510 kΩ	½ W	R ₃₂	15 kΩ	2 W	C ₃	8 μF	550 V
R ₂	510 kΩ	½ W	R ₃₃	100 kΩ	½ W	C ₄	8 μF	550 V
R ₃	100 kΩ	½ W	R ₃₄	50 kΩ	½ W	C ₅	50 μF	25 V
R ₄	15 kΩ	2 W	R ₃₅	39 kΩ	½ W	C ₆	5,000 pF	350 V
R ₅	47 kΩ	½ W	R ₃₆	39 kΩ	¼ W	C ₇	5 000 pF	350 V
R ₆	10 kΩ pot. linear (wire-wound)	2 W	R ₃₇	10 kΩ	¼ W			
R ₇	47 kΩ	½ W	R ₃₈	20 kΩ	2 W	C ₈	5,000 pF	350 V
R ₈	150 Ω	½ W	R ₃₉	5 kΩ	2 W			
R ₉	240 kΩ	½ W	R ₄₀	100 kΩ	½ W	C ₉	0.1 μF	350 V
R ₁₀	240 kΩ	½ W	R ₄₁	100 kΩ	¼ W			
R ₁₁	240 kΩ	½ W	R ₄₂	240 kΩ	¼ W	C ₁₀	0.1 μF	350 V
R ₁₂	15 kΩ	2 W	R ₄₃	600 Ω	¼ W			
R ₁₃	100 kΩ	½ W	R ₄₄	1.8 MΩ	¼ W	C ₁₁	3,000 pF	350 V
R ₁₄	510 kΩ	½ W	R ₄₅	39 kΩ	¼ W			
R ₁₅	510 kΩ	½ W	R ₄₆	39 kΩ	¼ W	C ₁₂	0.1 μF	350 V
R ₁₆	20 kΩ pot. linear (wire-wound)	2 W	R ₄₇	100 kΩ	¼ W			
R ₁₇	510 kΩ	½ W	R ₄₈	240 kΩ	¼ W	V ₁	EF 55	
R ₁₈	4.7 kΩ	½ W	R ₄₉	1.8 MΩ	¼ W	V ₂	"	
R ₁₉	20 kΩ pot. linear (wire-wound)	2 W	R ₅₀	39 kΩ	¼ W	V ₃	"	
R ₂₀	4.7 kΩ	½ W	R ₅₁	39 kΩ	¼ W	V ₄	6H6	
R ₂₁	47 kΩ	½ W	R ₅₂	100 kΩ	¼ W	V ₅	EF 55	
R ₂₂	47 kΩ	½ W	R ₅₃	1 MΩ	¼ W	V ₆	"	
R ₂₃	10 kΩ	1 W	R ₅₄	240 kΩ	¼ W	V ₇	"	
R ₂₄	20 kΩ pot. linear (wire-wound)	2 W	R ₅₅	1.8 MΩ	¼ W	V ₈	6J5	
R ₂₅	240 kΩ	½ W	R ₅₆	1 MΩ	¼ W	V ₉	6H6	
R ₂₆	15 kΩ	2 W	R ₅₇	1.5 kΩ	¼ W	V ₁₀	6SL7GT	
R ₂₇	47 kΩ	½ W	R ₅₈	15 kΩ	¼ W	V ₁₁	6SQ7	
R ₂₈	10 kΩ pot. linear (wire-wound)	2 W	R ₅₉	6.8 kΩ	¼ W	V ₁₂	6K8	
R ₂₉	47 kΩ	½ W	R ₆₀	3.3 MΩ	¼ W	V ₁₃	6K8	
R ₃₀	240 kΩ	½ W	R ₆₁	1 MΩ	¼ W	V ₁₄	6K8	
R ₃₁	150 Ω	½ W	R ₆₂	1.5 kΩ	¼ W	V ₁₅	6SN7GT	
			R ₆₃	220 Ω	¼ W	T ₁	1 : 11.5	Line/grid
			R ₆₄	220 Ω	¼ W	T ₂	"	"
			R ₆₅	470 Ω	¼ W	T ₃	"	"
			C ₁	8 μF	550 V	T ₄	4.44 : 1	Anode/line
			C ₂	500 pF	550 V (mica)	N ₁	Osglim "G"	
						N ₂	"	
						N ₃	"	

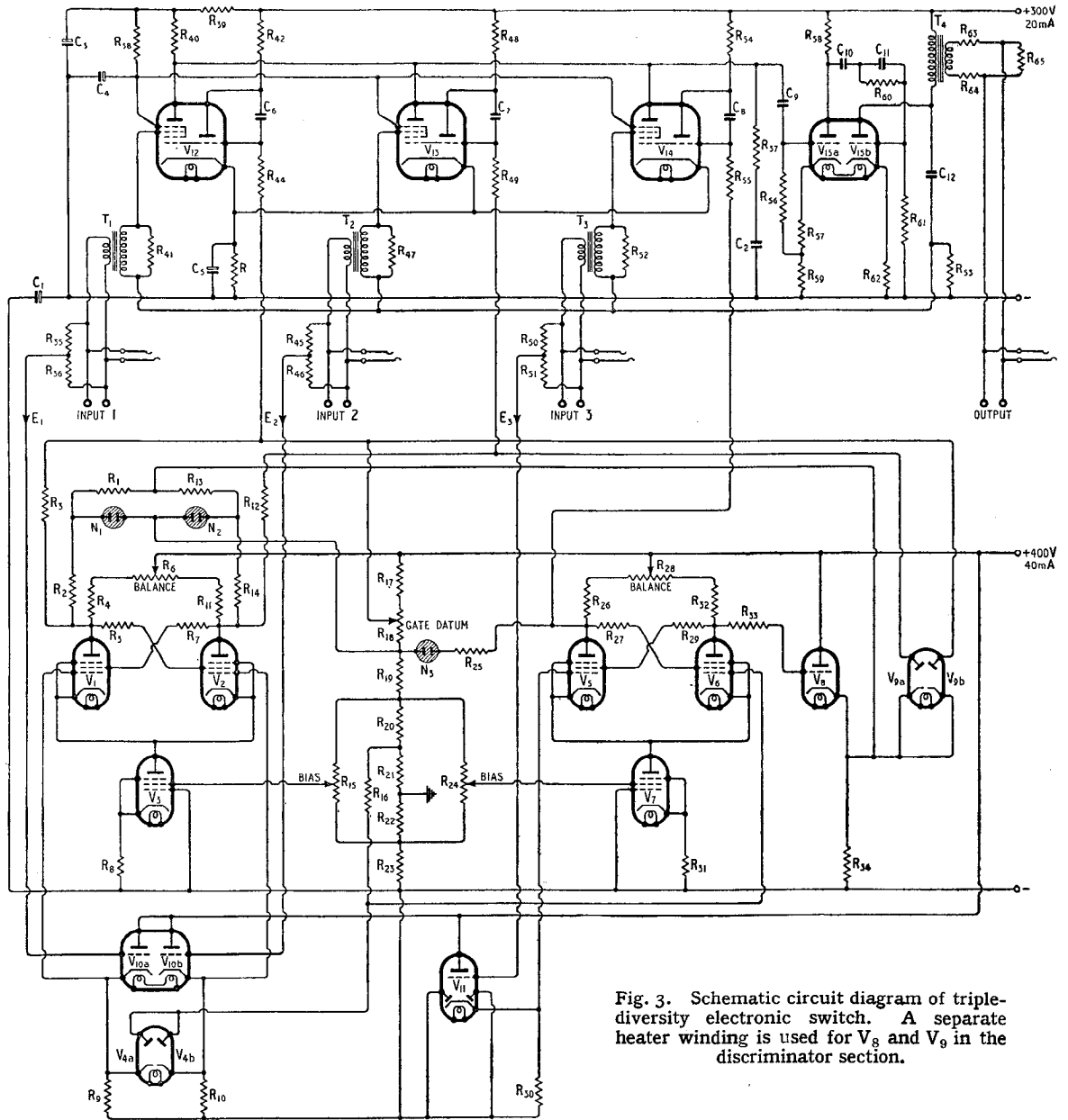

Fig. 3. Schematic circuit diagram of triple-diversity electronic switch. A separate heater winding is used for V_8 and V_9 in the discriminator section.

the anodes of the diodes, V_{4a} and V_{4b} , whose function is to select the "better," i.e., more negative, of the control potentials fed to V_1 and V_2 . Suppose, for example, that of the three signals No. 1 is the best (E_1 is, say -12 V); No. 2 is next best ($E_2 = -10$ V); and No. 3 is worst ($E_3 = -7$ V). The cathodes of the three cathode followers, V_{10a} , V_{10b} and V_{11} , will then change by like amounts, so that V_1 's grid becomes 12 V negative with respect to its no-

signal value; V_2 's grid changes by -10 V; and V_3 's grid changes by -7 V. Of the two diodes V_{4a} and V_{4b} , the cathode of V_{4a} has been changed by -12 V, whilst that of V_{4b} has changed by -10 V: V_{4a} conducts and its anode becomes equal in potential to its cathode; V_{4b} is cut off, because its anode is -2 V with respect to its cathode. Therefore V_6 's control grid has a change of -12 V impressed on it. The comparisons by the two discriminators are thus effected

as follows: V_1 and V_2 compare signals Nos. 1 and 2; V_5 and V_6 compare signal No. 3 with the better of Nos. 1 and 2. For simplicity, the anode voltages of V_1 , V_2 , V_5 and V_6 will be considered merely as being either positive or negative with respect to the slider of R_{18} , i.e., the negative pole of the gate h.t. supply; the anode will be positive when the valve concerned is near cut-off; it will be negative if the valve is heavily conductive.

Electronic Diversity Switching—

Further, if one valve of a pair has its anode positive, then the other must be negative. Reverting now to the example used in the previous paragraph, where E_1 , E_2 and E_3 are -12 , -10 and -7 volts respectively, it will be seen that the V_1 - V_2 pair are in the state where V_1 's anode is positive and V_2 's is negative; the V_5 - V_6 pair are in the state in which V_5 's anode is negative and V_6 's is positive. The operation of the gate valves in these conditions is as follows: V_{12} will be turned "on" by the positive potential from V_1 (thus signal No. 1—the best signal—is passed on to the output); V_{13} and V_{14} will be turned "off" by the negative potentials from V_2 and V_5 (hence signals Nos. 2 and 3 will be blocked). The resistors R_3 and R_{12} , through which the switching voltages are fed to V_{12} and V_{13} , are small compared with R_{44} and R_{49} and so they do not appreciably alter the switching time constant.

The function of the cathode-follower buffer, V_8 , and the diodes V_{9a} and V_{9b} , is to prevent the positive anode potential from V_1 or V_2 from being effective in turning "on" V_{12} or V_{13} if signal No. 3 happens to be the best one. It also avoids the faulty indication which would otherwise be given by one of the neon lamps, N_1 or N_2 . This action can best be illustrated by another example. Suppose that signal No. 3 is the best ($E_3 = -15$ V); signal No. 1 is next best ($E_1 = -10$ V); and signal No. 2 is the worst ($E_2 = -6$ V). The V_1 - V_2 pair operates in favour of E_1 , i.e., V_1 's anode is positive and V_2 's is negative; the V_5 - V_6 pair operates in favour of E_3 because V_5 receives -15 V (E_3) and V_6 receives -10 V (the better of E_1 and E_2). V_5 's anode is, therefore, positive and V_6 's is negative. The cathode of V_8 and hence the cathodes of the diodes V_{9a} and V_{9b} also will follow the potential of V_6 's anode and will become negative (with reference to the slider of R_{18}). The positive voltage at V_1 's anode is prevented from turning V_{12} "on" by the negative voltage from V_{9b} . The presence of R_3 increases the apparent impedance of the V_1 source and enables the potential from V_{9b} to override

that from V_1 . Thus both V_{12} and V_{13} are turned "off" and V_{14} , which is associated with the best signal, is turned "on" by the positive potential from V_5 's anode. The neon lamps N_1 and N_2 are each fed from two sources through high resistances. The potentials are such that the neons will light only if both sources are positive. Thus, in the last example, although V_1 's anode is positive and tends to strike N_1 it is prevented from doing so by the negative supply, through R_1 , from the cathode of V_8 . N_2 is also extinguished since it is driven from V_2 anode (negative) through R_{14} and V_8 cathode (negative) through R_{13} . N_3 is, however, illuminated by the feed from V_5 anode (positive) through R_{25} . This gives the correct indication, for gate-valve V_{14} is "open," signal No. 3 being the best.

The diodes V_{9a} and V_{9b} are necessary (as opposed to straight-through connections) in order that the negative potential from V_1 or V_2 can override, by cutting, off the appropriate diode, the positive voltage from V_8 cathode when the best signal is either No. 1 or No. 2.

Results in Service

After more than two years' experience with the electronic switch it is considered that the switched diversity system is superior to combined diversity, the effects of selective carrier fading especially being less marked. The receivers and aerials must, however, be more strictly matched than is usually necessary with the combining system, and more frequent routine examinations of the radio—and intermediate—frequency amplifier alignment are necessary. This is because the rapid change-over enables the ear to detect very small differences of background noise, a disparity of as little as 2 db being perceptible when the signal/noise ratio does not exceed 20 db. For this reason, when aerials having widely different characteristics are used, in "polarization diversity," for example, with weak or moderate signals, the change-over is marked by an abrupt change in the background noise. In these conditions it is preferable to increase the mix period beyond the 50 milliseconds,

which was adopted on other grounds, to about 150 milliseconds by increasing the value of the capacitors C_6 and C_7 (Fig. 2) or C_6 , C_7 and C_8 (Fig. 3). The change-over is then less abrupt and will generally be inaudible. Although rapid selective fades may occasionally cause distortion, the results are still superior to those of combined diversity.

"VIEW MASTER"

THE "View Master" is a television receiver sponsored by several component manufacturers and intended for the home constructor. It is for the London area, and the constructional details and wiring drawings are obtainable from wireless dealers, price 5s.

The set has a gin tube with electromagnetic deflection. Two valves are used in each time base and e.h.t. is taken from the line fly-back. The receiver has three r.f. stages with coupled pairs of tuned circuits for the intervalve couplings. Noise limiters are included.

The h.t. supply comes straight from the mains via a half-wave metal rectifier, and a transformer is only included for the valve heaters. The set is thus suited to a.c. mains only.

The drawings supplied are very clear, and, if carefully followed, no constructional difficulty should be encountered. The receiver must be aligned for single-sideband reception of the sidebands remote from the sound channel, and the use of a signal generator for this is advised. A procedure is given, however, for alignment on a signal.

NEWS FROM THE CLUBS

Basingstoke.—At the meeting of the Basingstoke District Amateur Radio Society on December 9th the design and construction of communication receivers will be discussed. The meeting will be held at the British Workmen's Restaurant, Basingstoke, at 7.45. Sec.: L. S. Adams, 16, Brambly Drive, Basingstoke, Hants.

Birmingham.—A talk on loudspeakers, with demonstrations, will be given to members of the Slade Radio Society by A. E. Falkus of Reproducers and Amplifiers, Ltd., at the meeting on December 9th at 7.45 at the Parochial Hall, Slade Road, Erdington, Birmingham, 23.

Northwich employees of Imperial Chemical Industries have formed the Crescent Radio Society, which meets on alternate Tuesdays in the works conference room. Membership is limited to employees of I.C.I. Sec.: W. Houseman, 15, Snowdon Street, Barnton, Northwich, Cheshire.

SUPPRESSING IMPULSE NOISE

New Type of Eliminator Operating on Pulse Duration

By D. C. ROGERS, A.M.I.E.E.
(Standard Telephones and Cables)

IMPULSE noise consists of very short bursts of electrical energy originating from atmospheric disturbances, or from such devices as switches, motor commutators, etc. These pulses of energy have a duration nearly always substantially less than one microsecond, and hence less than the response time of the radio-frequency amplifiers of the receiver and arrive at the detector with a duration which is dependent on the receiver bandwidth—in fact a duration which is of the order of twice the reciprocal of the receiver bandwidth. A further feature of these noise pulses, and one in which they differ from valve and circuit noise is that the interval between pulses is long compared with their duration at the output of the amplifier; in other words, they occur as separate pulses, and very rarely “overlap.”

Any circuit which is to discriminate against impulse noise must embody some means of distinguishing between the noise pulses and the desired modulation. In most circuits of the so-called

limiter type the noise pulses are distinguished by the fact that their amplitude is greater than that of the signal either before or after detection. For example, one well-known form of limiter is arranged to discriminate against any noise pulse whose amplitude exceeds twice the incoming carrier amplitude, this being the maximum value attained by the incoming signal at 100 per cent modulation. A circuit of this type cannot operate on pulses which have a small amplitude, but are nevertheless irritating to the listener.

Bandwidth Considerations

The circuit to be described¹ uses the duration of the noise pulse instead of its amplitude to distinguish it from the desired modulation; it is therefore capable of discriminating against noise pulses, even when their amplitude is equal to or smaller than the incoming signal.

It has been mentioned that the duration of the noise pulse at the detector is dependent on the receiver bandwidth, and that it decreases as the bandwidth is increased. In order to be able to discriminate against noise pulses without distortion of the desired signal, it is necessary for the pulse to have a duration less than that of a half-cycle of the highest modulation frequency. This implies that the bandwidth of the section of the receiver prior to the detector

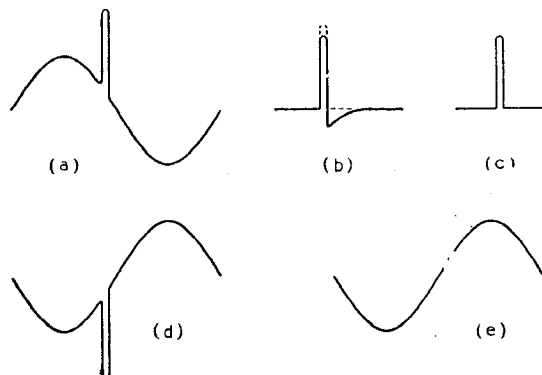

Fig. 1. Waveforms appearing at various points in Fig. 2

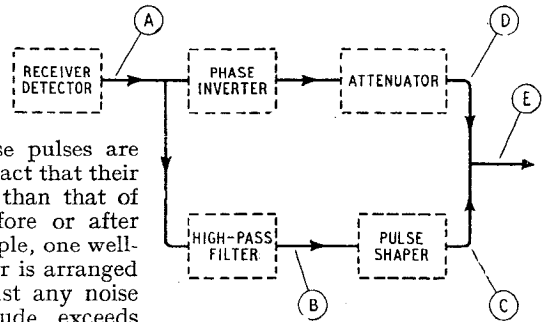

Fig. 2. Functional diagram of the circuit. The letters A, B, C, etc., refer to the points at which the waveforms of Figs. 1(a), (b), (c), etc., respectively, are observed.

should be greater than that needed for the reception of the transmitted modulation sidebands.

For this reason it will be seen that the use of the circuit is restricted to cases where selectivity is unimportant, and its application will generally be confined to frequencies above, say, 30 Mc/s. A typical case where it may be of use is in the sound section of a television receiver, where interference is frequently encountered from motor-car ignition and similar sources. It is not applicable to ordinary domestic broadcast receivers, or radio receivers of the “communication” type, where a high degree of selectivity is essential.

Principle of Operation.—The output of the receiver detector will consist of the desired modulation waveform, on which is superimposed a noise pulse, as shown in Fig. 1(a). The noise pulse may be analysed into a spectrum of frequencies extending from zero up to a maximum which is dependent on the receiver bandwidth, and, if this bandwidth is greater than that necessary to receive the transmitted carrier and sidebands, there will be noise components at frequencies correspondingly higher than the highest modulation frequency.

Referring now to Fig. 2, which

¹ Patents pending.

Suppressing Impulse Noise—

shows a block schematic diagram of the circuit, it will be seen that the output from the detector is fed into a high-pass filter. This filter transmits only those frequencies above the modulation band, and its purpose is to remove all modulation frequencies and the lower frequency components of the noise

The two outputs from the pulse shaper and attenuator are then combined, when the noise pulses, being in opposite sense, cancel completely, leaving the modulation free from noise as shown in Fig. 1(e).

Circuit Variants.—It will be apparent that it is possible to devise a variety of circuits

bandwidth of the receiver to the highest modulation frequency is so large that the filter can consist simply of a capacitance-resistance network shown by condenser C_1 and resistor R_1 ; two diodes are used to shape the pulse instead of one, as in Fig. 3, this arrangement presenting a higher impedance to the output of V_1 . In both circuits the two output voltages are combined by applying them to opposite ends of potentiometer R_2, R_3 , and taking the output from the junction of R_2 and R_3 . The ratio of R_2/R_3 is adjusted so that the voltage from the anode of V_1 suffers the requisite attenuation. (It should be noted that this method of combining the two voltages results in an additional loss of two-to-one in signal voltage.) The total resistance of this potentiometer can conveniently be about 1 megohm.

Suggested component values are shown in Fig. 4 for a modulation band of 10 kc/s and a high-frequency bandwidth of, say, 200 kc/s.

There is an alternative method by which substantially the same principle can be applied. Referring again to Fig. 1(b), it will be recalled that the effect of removing the negative "overswing" from the noise pulse as it emerges from the high-pass filter is to restore to it the low-frequency

pulse. This has the effect of distorting the noise pulse, as shown in Fig. 1(b). (The distortion can be seen by comparing with the dotted line in Fig. 1(b), which shows a noise pulse free from the modulation wave but undistorted.)

The distorted noise pulse then passes to the pulse shaper, where the overswing is removed, thus restoring the pulse approximately to its original shape, although with a slight loss in amplitude, as shown in Fig. 1(c).

The restoration of the pulse shape must clearly be equivalent to the re-insertion of the low-frequency components of the pulse, and, hence, the output from the pulse shaper consists of noise pulses of slightly smaller amplitude, but otherwise equivalent to those originally present in the detector output. A second output from the detector passes to a phase inverter, where the sense of the modulation wave and noise pulse is reversed, and thence to an attenuator which is arranged to give the same loss in amplitude as that suffered by the noise pulse in its passage through the filter and pulse shaper. The output from the attenuator is shown in Fig. 1(d).

which will perform the functions described above, differing, for example, in the form taken by the high-pass filter, the method of re-shaping the noise pulse, and the method of combining the output voltages. Two possible

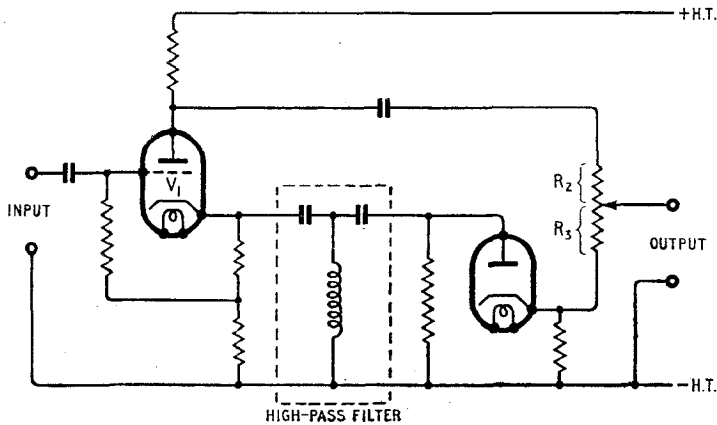

Fig. 3. Possible arrangement of a practical circuit.

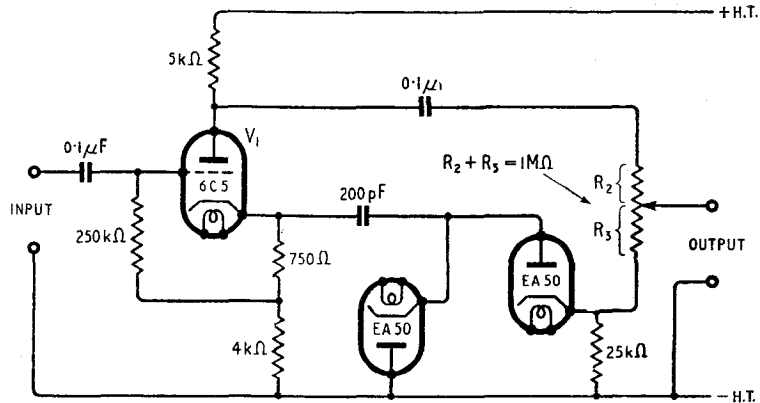

Fig. 4. An alternative circuit arrangement.

arrangements are shown in Figs. 3 and 4. In both these circuits the valve V_1 performs the two functions of inversion of the signal, and provision of a low-impedance source to feed the high-pass filter. In Fig. 4 it has been assumed that the ratio of the high-frequency

components which were removed by the filter. It may be deduced, therefore, that this negative "overswing," i.e., that part of the waveform below the zero axis in Fig. 1(b), must contain the low-frequency components in anti-phase. Hence, if the pulse-

shaping circuit is arranged to remove the upper part of the waveform of Fig. 1(b), and the residue is then combined with the original

trates the small number of components with which the circuit can be built. For the successful operation of this circuit, however,

radio-frequency amplifiers were tuned to 41.5 Mc/s (the frequency of the sound transmission of the B.B.C. television service) and had a bandwidth of about 200 kc/s. Impulsive noise was generated by means of an ordinary spark coil located near the aerial. The reduction in noise output, as measured by an "average" type rectifier meter, was 24 db. Subjectively, the improvement was such that an almost unintelligible noise became a programme of reasonable entertainment value.

The circuit also operated satisfactorily on other interference, such as from motor car ignition systems, although precise measurements were not made.

On occasions bursts of interference have been observed on which the circuit has not been effective. Whilst it was not possible at the time to take oscillograms, it was presumed that this particular noise consisted of

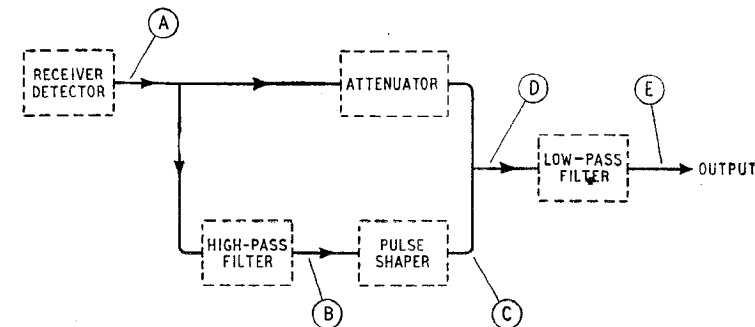

Fig. 5. Functional diagram of a variant of the circuit. The letters A, B, C, etc., refer to the points at which the waveforms of Fig. 6(a), (b), (c), etc., respectively, are observed.

waveform, this time without phase inversion, but with a suitable reduction in amplitude, the low-frequency components in the original noise pulse will be cancelled. The remaining high-frequency components can then be removed by a low-pass filter.

A functional diagram of this alternative arrangement and the waveforms appearing at various points in the circuit are shown in Figs. 5 and 6 respectively. A further note is necessary concerning the low-pass filter of Fig. 5. It is true that if the high-pass filter is designed to cut off at a frequency in the region of the upper limit of audibility, the noise components remaining at the output of the circuit will be above the audible range, and the loudspeaker, or indeed the human ear, would function effectively as a low-pass filter. However, any distortion taking place, due to valve non-linearity, in the amplifiers feeding the loudspeaker would result in the reintroduction of audible-frequency noise components. It is therefore very desirable that a low-pass filter should be provided to remove the high-frequency noise pulse components immediately after the combination of the original and re-shaped noise pulses, and before any further amplification takes place.

Again, it is possible to devise many circuits which will perform the functions indicated in Fig. 5. The circuit shown in Fig. 7 is of interest, however, since it illus-

it is necessary that the output impedance of the detector be very low, possibly as little as 1,000 ohms, if the output waveform of the detector is not to be distorted

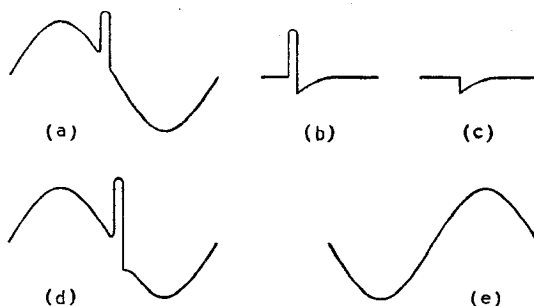

Fig. 6. Waveforms appearing at various points in Fig. 5.

by the severe loading imposed by the filter and diode combination. This low impedance will cause a considerable loss in gain, and in practice it would be preferable to use a cathode follower to feed the filter and diode.

It should be noted that in all the circuits described it has been assumed that the output from the receiver detector is in the positive sense. The necessary changes for negative output from the detector will be quite obvious.

Experiment.—A simple receiver, incorporating a circuit similar to that of Fig. 4, was built to test the effectiveness of the system. It consisted of two radio-frequency amplifier stages, a diode detector, audio-frequency amplifier and output stage. The

pulses of much longer duration, and, hence, the high-class filter and pulse re-shaping circuits were not able to operate satisfactorily. Fortunately this form of interference was found to be comparatively rare.

Conclusion.—It is believed that this method of reducing the effect

of impulse noise in amplitude modulation receivers represents a new approach to the problem. It will be seen that the only restriction imposed on the noise amplitude is that it shall be large enough to operate the pulse-

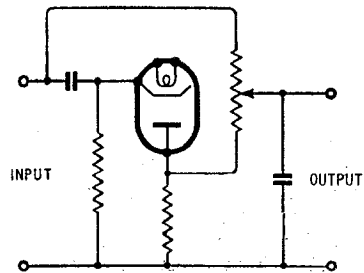

Fig. 7. A practical arrangement of Fig. 5.

shaping circuit correctly. No restriction exists on the ratio of the amplitudes of the noise pulse and the incoming signal.

In a recent article, Nicholson² suggests that frequency modulation offers little advantage over

amplitude modulation if the two systems are compared under similar operating conditions. He himself describes a new noise limiter by means of which an amplitude modulation receiver may be made superior to one for frequency modulation in its ability to discriminate against impulse noise. The circuits de-

scribed here achieve a similar object and will normally entail the use of less additional components in the receiver. It is probable that the overall cost of an amplitude modulation receiver, incorporating these circuits, would be less than that of the equivalent frequency modulation receiver.

ELECTRONIC CIRCUITRY

Selections from a Designer's Notebook

By J. McG. SOWERBY (Cinema Television, Ltd.)

PHASE splitters are widely used in audio amplifiers and were treated in some detail in this journal¹ some time ago. The notes that follow are merely disconnected jottings on a few points which, although not original, may be of interest to some readers.

Some Notes on Phase Splitters

One of the most widely used phase splitters is known as the "concertina" and is shown in Fig. 1(a). In this circuit a triode, V, has equal anode and cathode loads and these are effectively in series. Consequently, any signal current in the valve passes through both resistors and so equal output signal voltages are obtained at anode and cathode. The arrangement gives a gain of little less than one (usually about 0.9) between input and either output. It has the advantage that the balance of the output voltages depends only on the maintenance of equality of anode and cathode resistors. At (a) the bias for the valve is determined by R_b , which is small compared

with R_k . Consequently the cathode of V is positive to earth by anything up to 100 or more volts. This being so it seems logical to couple the grid of V directly to the previous anode as shown at (b), then the cathode potential of V will be very nearly the same as the anode potential of the previous stage. Besides saving three components the coupling eliminates any phase shift at low frequencies and this is often advantageous if V is within a feedback loop, as in Mr.

stage. The anode-cathode voltage of V is nearly $V_{ak} = (V_b - 2V_a)$ where V_b is the supply h.t. potential. From this we see that it is reasonable to design for $V_a = V_b/3$ or less. Even so, it is wise to ensure from the valve curves that no grid current flows in V even when V_a is 30% more than the design figure, making due allowance for the resultant reduction of V_{ak} . This arises because some variation in V_a is to be expected with time and with valve replacement.

Fig. 2(a) shows a cathode-coupled phase splitter in which the usual positive bias is supplied from a fixed potentiometer across the h.t. supply. A more economical arrangement is shown at (b)

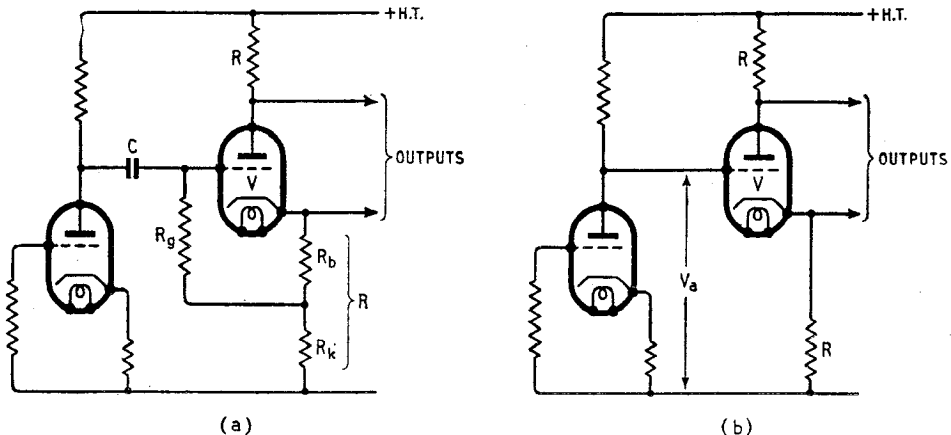

Fig. 1. "Concertina" phase splitter: (a) a.c. coupled, (b) direct coupled.

Williamson's amplifier². To a sufficiently close approximation the current in V can be taken as $i_a = V_a/R$ where V_a is the anode potential of the previous

using fewer components, in which the positive bias is the anode potential V_a of the previous stage. Both grids are obviously maintained at the same standing potential, but the signal is applied only to the grid of V, as the

¹ W. T. Cocking, *Wireless World*, Jan., Feb., March, April and May, 1948.

² D. T. N. Williamson, *Wireless World*, Aug. 1949, p. 282.

Electronic Circuitry—

“smoothing” circuit CR prevents the signal reaching the grid of V_2 . Similar time constants are used in the two circuits, and at medium and high frequencies the performances are identical. At very low frequencies, however, CR in circuit (a) merely leads to attenuation of both outputs, whereas (b) reverts to a push-push output of low gain as the frequency approaches zero, because the grids of V_1 and V_2 both follow the anode potential of the previous stage, and are in phase with one another.

may have undesirable results on subsequent stages.

In designing the circuit of Fig. 2(b) the anode current of V_1 or V_2 may be taken to be $V_a/2R_c$ and the anode-cathode potential of each valve will be $V_{ak} = V_b - V_a(\tau + R_a/2R_c)$ nearly. Previous remarks concerning grid current in the circuit of Fig. 1(b) apply here too.

Some designers are disinclined to use the “concertina” and cathode-coupled circuits as both involve operating the cathode of a valve at a considerable potential to earth. A commonly used

necessary to make R_{a1} less than R_{a2} to obtain equality of output voltages. On analysis it turns out that

$$R_{a1} = R_{a2} \left[\tau - \frac{r_a + R_{a2} + 2R(\tau + r_a/R_{a2})}{r_a + R_{a2} + (\mu + 1)R} \right]$$

where $\mu =$ amplification factor
 $r_a =$ a.c. resistance
 of either valve

for equal signal output voltages. In practice it is convenient to

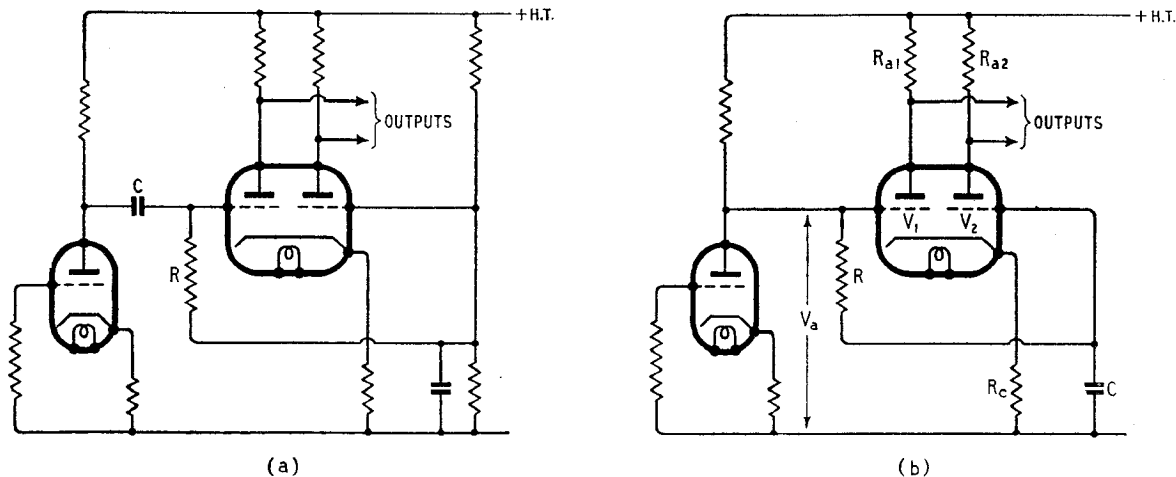

Fig. 2. Cathode-coupled phase splitter with two types of coupling.

An advantage of circuit (b) compared with (a) is that a large value of C can easily be used—say $2\mu\text{F}$ or more. Such condensers are usually of the paper-block-in-metal-can type and if used in the circuit at (a) may lead to loss at high frequencies due to the additional stray capacitance at the grid of V_1 . One such condenser measured by the writer recently had a condenser-can capacitance of more than 100 pF, and if such a condenser is fixed to an earthed metal chassis and used as a coupling condenser in (a), that 100 pF will appear between the grid of V_1 and earth. In the circuit at (b) this condenser-can capacitance will only add to C, and so be slightly beneficial.

The circuit of Fig. 2(b) has a disadvantage inasmuch as variations in the h.t. supply potential may lead to a large push-push output from the splitter, and this

alternative is the “see-saw” circuit. Another circuit which might be regarded as a combination of the cathode-coupled and see-saw arrangements if available, however, and is shown in Fig. 3. It will be remembered that the cathode-coupled circuit of Fig. 2 tends to maintain equality of signal currents in the two valves, and that exact equality is approached as R_c is increased, eventually becoming exact when R_c is infinite. The circuit of Fig. 3 behaves in exactly the same way, provided that we substitute R for the R_c of Fig. 2. However, in this case there must always be some signal voltage across R (to operate the grid of V_2) and this signal will be in phase with that obtained from the anode of V_1 . Consequently, however large R may be made to achieve equality of signal currents in V_1 and V_2 , it will always be

make R_k the common bias resistance for the two valves; this largely controls the direct current through the two valves and hence through R. Next, R is made as large as possible having due regard for the voltage drop across it. R_{a2} is then fixed, and R_{a1} calculated. The time constant $C_1 R_{g1}$ is calculated as for a normal amplifier stage, and it is preferable to make $C_2 R_{g2}$ several times larger than $C_1 R_{g1}$ to maintain a phase displacement of 180° between the output signals at low frequencies.

The gain from input to either output (when R_{a1} is properly chosen by means of the preceding equation) is

$$A = \frac{\mu R_{a1}}{r_a + R_{a1} + \frac{R_{a2} - R_{a1} R}{R_{a2} + R}}$$

Substitution of practical values indicates that this circuit yields a

gain approaching twice that for the ordinary cathode-coupled circuit of Fig. 2 when $R_c = R$, and the other constants are the same in both circuits. In this respect the splitter of Fig. 3 is more like the see-saw from which a correspondingly increased gain can also be obtained, and it also suffers from the disadvantage that any disturbances on the h.t. line are fed preferentially to one grid, so that the arrangement should be used only with a well-smoothed supply.

In using the circuit of Fig. 3 and see-saw circuits one point needs watching. A common bias resistor is quite in order as long as it is bypassed. If it is not, then as there is feedback from both anodes to one grid, and feedback from one valve to the other via the cathode resistor, an unfortunate accidental combination of stray capacitances may easily turn either circuit into a cathode-coupled multivibrator³ at high frequencies. A relatively small cathode bypass capacitor will stop this trouble completely, but may also lead to a non-uniform

frequency response. By using a capacitor of more usual value—20 to 100 μF —these faults are

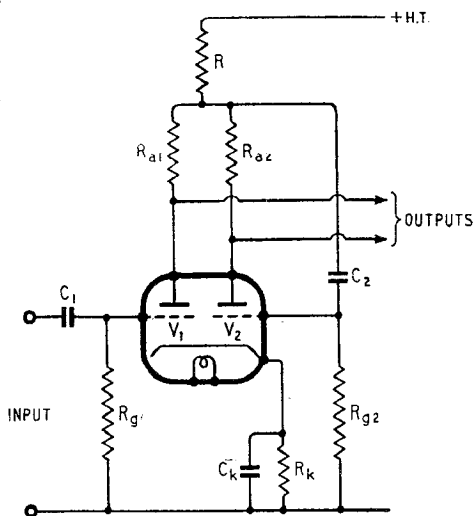

Fig. 3. Common-anode-coupled phase splitter. Typical values: $V_1, V_2 = 6\text{SN7}$, $R_{g1} = R_{g2} = 1\text{M}\Omega$, $R_k = 1.8\text{k}\Omega$, $R = 39\text{k}\Omega$, $R_{a1} = 80\text{k}\Omega$, $R_{a2} = 100\text{k}\Omega$, $C_1 = 0.05\ \mu\text{F}$, $C_2 = 0.25\ \mu\text{F}$, $C_k = 20\text{--}50\ \mu\text{F}$, h.t. = 350V. Gain (input to one output) = 17 (approx.).

both removed. If this is omitted and "multivibration" takes place, the amplitude may be quite low and of quite high frequency—100 kc/s or more—and so difficult to find except with an oscilloscope, of low input capacitance, or a high-impedance valve voltmeter.

this varies the leakage field used for focusing. Unequal adjustment to the screws tilts the core tube and so moves the picture on the tube and provides a shift control.

Because focus and shift are carried out by the same three screws the two are interdependent but, in practice, the adjustment is by no means difficult. The focus obtainable on a test was as good as with an electro-magnet and is free from "warming-up" drift. It is not, of course, free from any change brought about by variations of the tube e.h.t. supply. The magnet has a much larger external field than the usual electro-magnet and it may be necessary to take this into account if valves are mounted very close to it.

There are three types of magnet; the R17 at 21s for tetrode tubes, the R20 at 22s 6d for triodes at medium e.h.t. voltages and the R25 at 25s for triodes operating at high voltages. The makers are Electro Acoustic Industries, Ltd., Stamford Works, Broad Lane, Tottenham, N.15.

Portable Radio-Amplifier

DESIGNED for use in small factories, schools, etc., the "Hadley" portable radio-amplifier is housed in a metal case 18in x 9in x 9in and provides facilities for relaying radio programmes, gramophone records and microphone announcements.

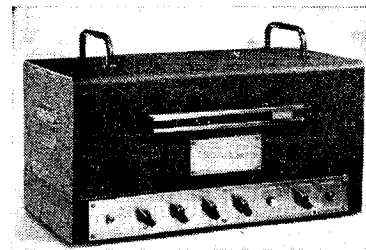

"Hadley" portable radio-amplifier.

There is a choice of four pre-selected radio programmes, and both radio and gramophone are automatically cut off when the microphone is switched on. A self-contained oscillator provides a push-button-controlled tone for time signals or fire alarms.

A small built-in loudspeaker unit with independent volume control is provided for monitoring.

The power output is 20 watts and the mains consumption is 120 watts at 200-250 V, 50-60 c/s. The price, including tax, is £52 7s 9d and the makers are Hadley Sound Equipment, 587-9, Bearwood Road, Smethwick, Birmingham, 17.

³ "Electronic Circuitry." *Wireless World*, July, 1948, p. 249.

NEW PRODUCTS

Mica Trimmers

THE new "M" type trimmer introduced by the Plessey Company, Ilford, Essex, is of particularly robust construction and very stable in operation. The construction of the multiple units simplifies mount-

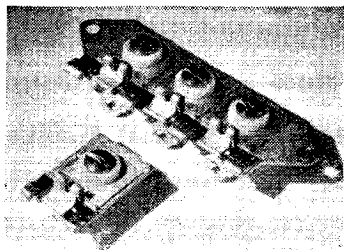

Single and multiple units of the Plessey "M" type trimmer.

ing and permits economy in space where a common earth is acceptable. Single capacitors are also available.

Best quality mica, with a power factor of approximately 10×10^{-4} measured at 1 Mc/s, is used and the insulation resistance is greater than 1,000 M Ω at 500 V d.c. Capacitance range is 5-65 pF.

P.M. Focus Unit

THE Elac permanent magnet focusing unit replaces the commonly used electro-magnet for focusing the electron beam of a cathode-ray tube. It comprises a ring-type permanent magnet with fixed end cheeks and an inner core tube which is adjustable by three screws. Equal adjustments to the screws move the core tube along the axis and so vary the air gap between the tube and the front end cheek. In its turn

Why we designed the STEREOPHONIC AMPLIFIER

In our search for really high quality we had already built an amplifier of .01 per cent. distortion and 40 times damping factor, which we believe is the finest straight amplifier in the world. Unfortunately we have been unable to obtain a single speaker which will faithfully reproduce the whole range, and when used to drive twin speakers via a cross-over network these introduced more distortion and peaks than could be tolerated. From this we drew the following conclusions.

The attainment of really high quality had always been marred by defects at the speaker end of the reproducer which were:—

- (a) The inability to cover the whole audio range with handling capacity of 8 to 10 watts at the lowest piano frequency of 26 cycles.
- (b) The interference caused by the Doppler effect, or where this has been minimised, the lack of speech coil feedback and damping at frequencies where that particular speaker should be silent.
- (c) The variation in acoustic power at the ends of the audio band, or the difference in efficiency of the two speakers when fed by cross-overs after the amplifier.
- (d) The resonance of the choke and condenser network at various frequencies which in one case gave a variation of 5 ohms to 105 ohms for a nominal 15 ohms impedance.

All these points were considered, and an amplifier was then designed and built to overcome all those deficiencies, the audible results exceeded expectations and a stereophonic effect was noticed on some records and the amplifier accordingly called "Stereophonic."

The requirements of triode cathode follower and 8 to 10 watts output is best met by PX4's, since their mains consumption is low compared to pentodes strapped as triodes and heater hum does not bother a cathode follower. A single valve is capable of the equivalent acoustic requirements at the higher frequencies. The cross-over is fitted in the middle of the amplifier where it is not concerned with power transfer and does not introduce resonance or distortion.

Superlatives fail in the description of the quality of reproduction from this new amplifier, but may we just say it gives the finest quality reproduction of any unit, some costing almost a thousand pounds, that we and many others have heard. This is due to the lack of resonances from the loud speakers, with the result that needle scratch is barely audible, even with the full audible frequency range.

Unlike most reproducers where bass is reduced to ensure good unmodulated treble it is possible in this case to retain the full richness of the bass without interfering in any way with the treble response, and the lowest organ note to the highest strings can be reproduced at the same time without modulation distortion. This high quality is maintained even at whisper strength to an abnormal degree.

In these few words we cannot convey just how good this quality of reproduction really is, but we do invite you to a demonstration, and if possible bring your own well-known test records, upon which to base your judgment

Chassis complete with valves

Price 36½ gns.

VORTEXION LIMITED, 257-261 THE BROADWAY, WIMBLEDON, LONDON, S.W.19
Telephones LIB 2814 and 6242-3 Telegrams "Vortexion, Wimble, London"

DECEMBER — MONTH OF GOOD CHEER

And why not? We are cheered by the knowledge that our products will bring pleasure to crowds of good people, the world over, and that is cheery compensation for our 20 years concentration on the design and production of Quality Equipment—not purely for the money, but for the sheer fun of producing something better.

May we also wish a Merry Christmas to all fellow enthusiasts?

TONEMASTER AMPLIFIER

R-N-W PICK-UP

DX PLUS 2 RADIO UNIT

CONCERT GRAND—

SUPER LOUDSPEAKER

They are sound by name
and nature—
uplifting in quality.

Write for details of our latest ideas—better still call at

OUR NEW OFFICE and SHOWROOM

125, OXFORD STREET, LONDON, W.1.

GERRARD
8 7 8 2

Sound Sales Limited

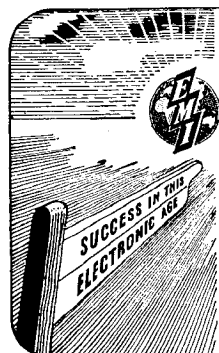

PLAN YOUR CAREER

RADIO • TELEVISION
and other INDUSTRIAL
ELECTRONIC subjects
ELEMENTARY & ADVANCED COURSES

WRITE FOR FREE BOOKLET summarising careers available in Electronics and giving particulars of Courses offered by E.M.I. Institutes.

The booklet contains full details of elementary and advanced HOME STUDY and DAYTIME courses in Radio, Television, Telecommunications and Industrial Electronics.

Courses ideal for those seeking recognised qualifications are also available.

Payment for tuition can be made in easy instalments if required.

Write to Dept. 16A

E.M.I. INSTITUTES

43, GROVE PARK ROAD, LONDON, W.4. CHLewick 4417/8

Associated with
"H.M.V."
MARCONIPHONE
COLUMBIA
ETC.

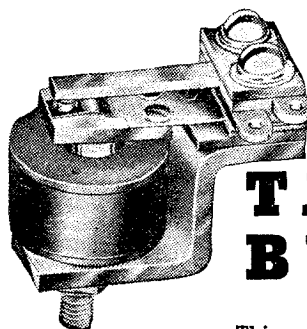

THE TAYLOR BUZZER

This small buzzer has a number of applications, such as continuity testing, a signal for telephones and communication circuits, or as a source of interrupted supply for bridge circuits.

It operates at approximately 500 cycles per second, and the consumption at 3 volts is very approximately 100 mA. Also it will operate satisfactorily from 4 volts A.C. 50 cycles.

TAYLOR ELECTRICAL INSTRUMENTS LTD
419-424 MONTROSE AVENUE, SLOUGH, BUCKS, ENGLAND
Telephone SLOUGH 21381 (4 lines) Grams & Cables TAYLINS, SLOUGH

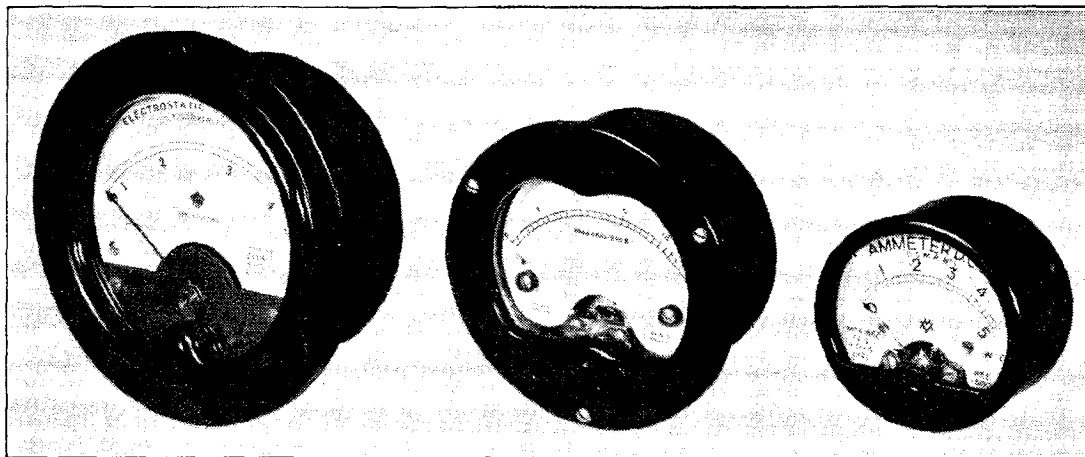

POINTER INSTRUMENTS

INDICATING instruments of the pointer type are commonly incorporated in test gear, using the term widely to cover valve voltmeters, oscillators, bridges, attenuation meters, Q meters, output meters, etc. They are included for one of two purposes; they may provide the final means of indication, as in valve voltmeters, Q meters, etc., or they may be merely a means to an end such as assisting the correct setting of voltage and current in oscillators, bridges, etc. In the former case a larger size is normally required than in the second, where several instruments may be needed, all ancillary to the final measurement or other output.

Specifications for indicating instruments include B.S.89:1937 (now under revision).—This covers chiefly performance, but also includes desirable constructional and other features. Dimensions are not covered in it, but an inter-Service Specification, K113, is largely complementary, and gives dimensions for overall size and fixings. This renders instruments interchangeable as regards mounting, while leaving individual designers free to modify the movement design as required.

An inter-Service Specification for hermetically-sealed instruments for use in all climates from tropical to arctic is in preparation and has been circulated in draft

Types for Test Gear

By **E. H. W. BANNER**,
M.Sc., M.I.E.E., F.Inst.P.

form. Instrument sizes include 2, 2½ and 3½ in, all in metal cases for flush mounting.

Tests specified include a full 84-day tropical cycle, involving dry and wet heat, dust, water immersion, mould growth, etc. Vibration and bumping tests are prescribed, as are many details of design and construction.

Another inter-Service specification dealing with equipment under extreme physical conditions is K.114, "Climatic and Durability Testing of Service Telecommunication Equipment."

The sizes in most demand for test gear are the so-called miniature series. These started with the 2½ in (a nominal size), which is a compromise between small size and length of scale. The latter is just sufficient for a reading accuracy of 1 per cent of full-scale deflection near full scale. Next came variations up and down; a 3½ in type which gives a better reading accuracy, as well as enhanced

scale visibility, and a 2 in pattern. This has a lower reading accuracy and so is hardly good enough for first-grade accuracy, but it is of great application where small size is of more importance than accuracy. During the 1939-45 war Lipman, of Nalder Bros. and Thompson, Ltd., produced a sub-miniature design in which the permanent magnet is inside the moving coil, and only a small iron ring surrounds it. This is a 1½ in instrument, and is extremely useful where minimum size and weight are the most important features and accuracy is second. Finally, an extension in the upward direction is the 4 in, which really overlaps the former switchboard range of instruments, but is in a moulded case instead of metal as are most larger switchboard instruments. All these are round-pattern instruments, usually available for mounting either flush or projecting, flush being most common; the 4 in may be in a square case or have a square flange on a round body, the latter also applying to the 2 in.

In addition to the above sizes to K113 another maker has for years supplied a nominal 2½ in instrument which is larger than the K113 dimensions, but which has the advantages of a longer scale—2½ in—more room inside for additional ranges and higher self-contained ranges. It is even

Typical instruments of the 2 in to 3½ in types are illustrated above.

Pointer Instruments—

possible to include an internal range-changing switch.

Shapes, other than round and square, include a sector $2\frac{1}{2}$ in. projecting; and edgewise, horizontal and vertical mounting, flush. None of these is covered by K 113, but each has applications. Sector instruments have longer scale length for given area of instrument front than a corresponding round type. For minimum panel space, therefore, the edgewise pattern scores, but it has the limitation that it is necessary to use a smaller scale arc to avoid parallax.

The 4in type is not covered by any Specification. In some makes, however, it comprises a square flange, containing the pointer and dial, with a round body mounted flush in a hole which is standard for the $3\frac{1}{2}$ in flush pattern. In this way it partly complies with K 113, and its mounting is interchangeable, except that the panel space is greater, which leads to wider spacing for adjacent instruments. The projecting pattern 2in and $2\frac{1}{2}$ in sizes are also manufactured with a two-pin plug for socket mounting, which makes their rapid removal and changing easy. Illumination is provided in some instruments on the market. Generally, the lamp is external, with a window in the instrument case, and for ease of renewal this is preferable to an internal lamp. The 4in flange instrument mentioned above may be of this type, with a translucent dial.

For an instrument such as a valve voltmeter, where the instrument dial is the only part of real interest to the user, the 4in, or the $3\frac{1}{2}$ in, are the two best sizes, for they give maximum scale length and reading accuracy. Many of these instruments are so mounted in output meters, Q meters, X-ray monitors, etc.

Moving-coil Meters

The moving-coil type is nearly universal for direct-current measurements, but for high-voltage ranges the electrostatic voltmeter is often preferable, especially as it requires no current, and so has, in effect, infinite ohms-per-volt resistivity. Shunted

moving-coil instruments usually have a volt drop of 75 mV, in accordance with B.S. 89, but this is not necessarily the case for low ranges with internal shunts. As voltmeters, resistivities of 200 and 1,000 ohms per volt are common, with 5- and 1-mA movements respectively, but as microammeters down to $5\mu\text{A}$ full scale are made by some firms, they may be made into voltmeters with resistivities up to 200 kilohms per volt.

Where mains voltage or current is to be measured, the moving-iron type of movement is the best, but it is not made in all the sizes and shapes given above. Minimum ranges for miniature instruments are about 1 A and 10 V; below these ranges rectifier instruments are available down to a few

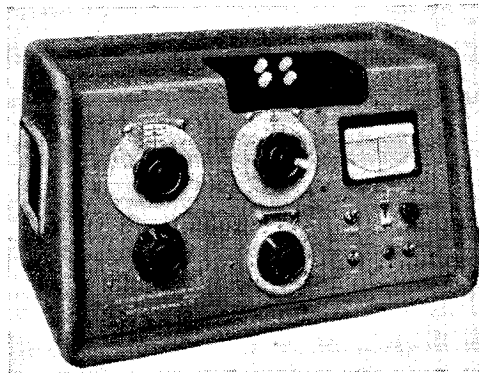

Marconi Instruments H.F. Circuit Magnification Meter using a square-face instrument for its built-in valve voltmeter.

microamps and 1.5 V, but the limitations, referred to later, should be noted. Also available with the moving-iron movement for mains use is the induction type, miniature sizes of $2\frac{1}{2}$ and 4in being available in round-pattern cases. The great advantage of this type is, of course, the long scale arc of about 330° , which provides a scale length of 5in in the $2\frac{1}{2}$ in instrument.

For very high voltages the electrostatic type is again often to be preferred as for d.c.; it has a lower bulk than any electromagnetic type with its associated resistor or transformer. The current consumption of the electrostatic voltmeter on a.c. is also very small, depending on the capacitance, and this current is wattless.

At audio frequencies the recti-

fier instrument is supreme, with its wide frequency range up to about 100kc/s. Rectifiers are being developed for the Mc/s range, apart from the use of crystal rectifiers for h.f. circuits. Ranges of microamps and milliamps are directly available and higher ranges by current transformers. Thermal instruments may also be used, with the advantage of independence of waveform, but their lack of robustness restricts their use when rectifier instruments will serve.

High Frequencies

At high frequencies the thermal types have the field, with a very high upper frequency limit. They are nearly equally accurate on direct current, and completely independent of waveform, reading the true r.m.s. value. The thermocouple type is better than the old hot-wire type, although more expensive. Generally ranges from 10 or 20mA upwards are available. All thermal instruments suffer from a lack of robustness due to the low overload capacity, as the working wire is heated to a temperature approaching its melting point at full-scale deflection.

There is a tendency on the part of many engineers to specify and use rectifier instruments for all a.c. circuits. But as already mentioned, moving-iron instruments are better for normal ranges at power frequency, partly because of the lower cost, but mainly because the rectifier instrument reads the mean value of the rectified current and as r.m.s. value is normally required, and the instrument is so calibrated, there is a waveform error which may be quite serious, although frequently overlooked. Further, the rectifier has an effect on the a.c. circuit, when the circuit is a low-power one, due to the resistance of the instrument varying with current and not remaining constant as for other types. At low currents the resistance, or impedance, is many times that at full-scale current. On the other hand, the advan-

tages include the good damping and snappiness of response of the moving-coil instrument, and lower consumption and lower minimum ranges than for other a.c. instruments. Most instruments of this type have a self-contained metal rectifier, either copper-oxide or selenium, but any moving-coil instrument may have an external rectifier. This is of use for the $1\frac{1}{2}$ in instrument, where there is no room inside the very small case for a rectifier.

Other factors to consider in specifying a suitable instrument include whether the panel on which it is to be used is ferrous or non-ferrous. Most miniature instruments are in moulded cases and have no internal shielding, so that there is a tendency to stray field error. This may be shown up by a steel panel, hence the need for having an instrument

calibrated on a panel similar to that on which it is to be used. Electrostatic voltmeters may be similarly affected by electrostatic fields and a metal panel, not only a ferrous panel, will act as a screen and may affect the readings if it is not taken into account in the calibration. It may also be affected by local high-voltage fields.

Scales and scale marking require much care to ensure maximum legibility and to give all necessary information, while excluding extraneous matters of no interest to the user. B.S.89 lays down scale proportions, relative lengths of scale marks, etc. Scale factors of 2 and 5 are recommended as a compromise between the minimum number of ranges to overlap and the maximum percent scale reading for any numerical quantity. A scale factor of 3

is not recommended, although it has applications to cell-testers.

It is generally desirable to indicate on the scale the type of the instrument, or its range of measurement. A linearly scaled instrument marked "Milliamperes" and scaled 0-10 may be either moving-coil or rectifier, and so should be unmistakably marked which. Such an instrument could either be scaled "Milliamperes D.C." (or A.C.) or else a symbol showing d.c. or a.c. used, or the symbol for a rectifier instrument added, preferably both, as an a.c. ammeter may be moving-iron or rectifier and not always readily distinguishable by its scale shape. Symbols for this have been proposed for international use and have been adopted in some countries, and by some makers here, for many years. Their general employment is to be commended.

RECORDS UNDER THE MICROSCOPE

Microphotography as an Aid to Research

AT a meeting of the British Sound Recording Association, on 21st October, C. E. Watts described the apparatus he uses to obtain the very instructive microphotographs of record grooves, cutters and styli for which he has acquired a well-deserved reputation.

By the use of polarized light and careful adjustment of the angle of incidence, it is possible to bring into relief any effects which may require prolonged and detailed examination; for example the angle of ejection of swarf from the cutter, its subsequent spontaneous expansion and the reasons for the generation of subsidiary shavings. Similarly, the walls of the groove can be examined for signs of wear, and the lines of contact (if any) between the needle tip and the groove walls during playback can be traced.

Mr. Watts has also devised a means of viewing the contact between stylus and groove under actual playing conditions, and he has stated that on loud passages "daylight" could be seen at these points for most of the time, even with the lightest of modern lightweight pickups. The only arrangement showing any semblance of continuous contact consisted of a fragment of sapphire broken from the extreme tip of a stylus and cemented to a segment of watch hair spring.

The surprising thing was that the lack of continuous contact did not seem to have any detectable effect on the quality of even the best recordings, as judged by critical and experienced listeners. It came as something of a shock to many of these people to be shown the movement of the stylus relative to the groove after having praised the

quality of a recording. Was it possible that the quality of modern disc recordings is better than the ear can appreciate.

That such a question should ever arise was in itself a tribute to the value of microphotographic methods in recording research, and provided the stimulus for continued investigation along these lines.

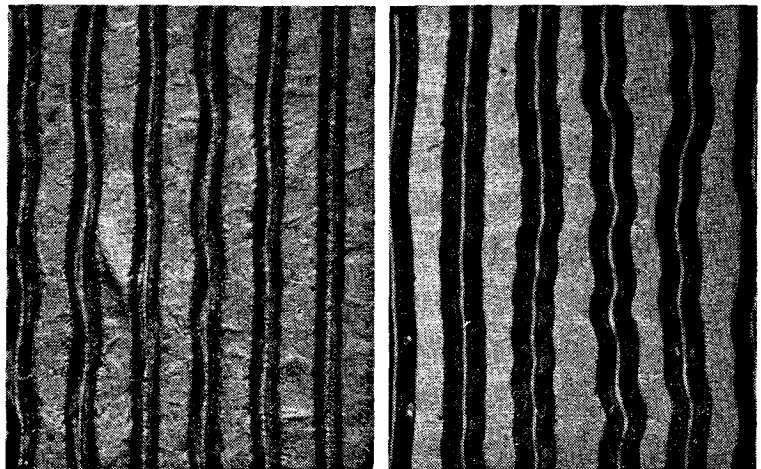

Two untouched microphotographs by C. E. Watts illustrating 50 years' progress in disc recording. On the left is an early Berliner pressing (circa 1899) and on the right a modern (1949) pressing.

Unbiased

By FREE GRID

On Exhibitions

COMPARISONS are said to be odious but are none the less useful on that account, and in any case who am I to discard what great men like Attlee and Churchill both freely use? The comparison which I wish to draw is between the running of Radiolympia and two other exhibitions which happened to have their doors open at the same time as the wireless show. I refer, of course, to the exhibition of the Royal Photographic Society and to the Motor Show.

Now both these exhibitions, which I studied in some detail, fell lamentably short of Radiolympia in two opposite directions. In the case of the photographic exhibition there was on show the results given by the apparatus which the photographic industry makes and sells, but no attempt was made to show the apparatus itself. In the case of the Motor Show the apparatus was exhibited but results in the shape of free rides for all were singularly lacking. At Radiolympia, on the other hand, not only was the apparatus exhibited, but the results obtainable from it were demonstrated for all to see or hear, as the case may be.

It is true that in the case of the photographic show no sordid charge was made for admission but we were all invited to disclose our identity by signing the visitors book and a somewhat expensive catalogue was brought to our notice by the presiding goddess. Fortunately, I had Mrs. Free Grid with me and she quickly dealt with the goddess and took entire charge of the proceedings rather too thoroughly, in fact, as I was quickly piloted past photographs belonging to the "Sep-

tember Morn" school of art.

My object in going to the Motor Show, apart from comparing it with Radiolympia, was to choose a car for a grandson who is expected to enter this world shortly. My daughter and son-in-law have journeyed specially to the land of dollars for the event so that he will be entitled to American citizenship. On his arrival in this country with his parents, who will, of course, retain their British nationality, he will be able to have immediate delivery of as many new cars as he pays for provided that he makes no attempt to sell them. I, as one of his duly appointed chauffeurs, will have the use of one of them. The idea is Mrs. Free Grid's, but I cannot help feeling that there is a snag in it somewhere.

At any rate, after all this it was with a great sense of relief that I arrived at the well-organized and racket-free radio show in which both apparatus and the results they gave were freely exhibited, and the former freely sold to all without subterfuge.

Applied Science

ACCORDING to one of the more sober Sunday newspapers experiments are being made at one of our great airports to find a remedy for the danger caused by the collision of large birds with aircraft, which constitutes a very real menace. Apparently the trouble is particularly prevalent and exceptionally dangerous when aircraft are hurtling down the runway to take off or land.

A certain amount of success appears to have been had by taking advantage of the fact that birds, like dogs and certain other animals, can readily hear frequencies which are supersonic to human ears. Supersonic sounds, if I may use such a contradictory expression, are, therefore, generated which scare the birds without annoying the passengers. I cannot, however, see why a bird should be scared of a 20,000 c/s note and yet remain stolid and phlegmatic at hearing the appalling roar of the aircraft's engines, but doubtless my ignorance of ornithological psychology accounts for this. Unfortunately, the supersonic frequencies are disliked by dogs who set up a mournful

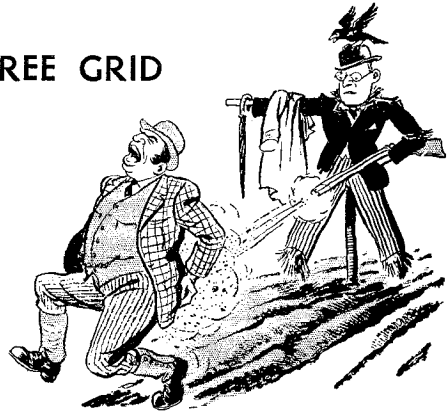

Painfully Peppered

howling which reminds superstitious passengers of banshees and causes those awaiting the departure of their planes to hurriedly cancel their passages.

Personally, I should have thought that the problem could have been solved by using simple radar beams which on striking the birds rebounded and thereby operated a series of shotguns suitably mounted in the nose of the plane and I offer this suggestion, without charge, to the harassed authorities. Doubtless they can improve upon it; but I do know what I am talking about as some time ago I was called into consultation by a farmer who was troubled with marauding birds. They treated the ordinary scarecrows with contempt and did the same even when loudspeakers, concealed in the clothing of each scarecrow and coupled to an outside in amplifiers housed in a nearby barn bellowed forth the B.B.C. Third Programme.

I quickly designed a series of radar scarecrows which were triggered off by the approach of intrepid and insolent birds, and in their turn triggered off a concealed shotgun. Unfortunately, the radar apparatus was no respecter or discriminator of persons and the farmer was well and painfully peppered one day when he approached too near one of them.

I offered to design for him and members of his staff a special I.F.F. unit which they could carry on their persons, the idea of this being that when a beam from a scarecrow struck them it caused an answering signal to be sent out which temporarily short-circuited the gun-operating mechanism. However, he was not long-sighted enough after the accidental peppering incident to proceed with the idea even though I pointed out to him that the radar scarecrow would deal impartially with either trespassers or birds.



Quickly Piloted.

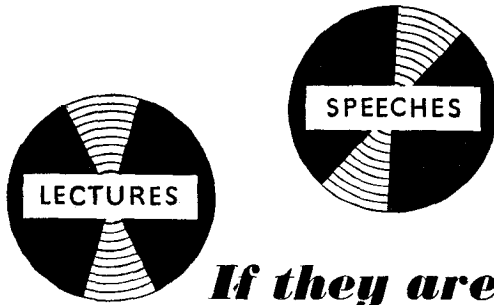

***If they are worth hearing . . .
they are worth recording!***

Simple to operate and readily portable, the E.M.I. Portable Disc Recorder enables brilliant "on the spot" recordings to be made of outstanding events. Produced by E.M.I. technicians with 50 years' experience in recording, this new E.M.I. Portable Recorder is a remarkable technical achievement. Here in transportable form is a complete recording and play-back equipment designed to produce high quality recordings on lacquer blanks without demanding expert knowledge of recording technique. Operation is extremely easy and the equipment which is contained in three transportable cases needs 200/250 volts 50 cycles A.C. mains supply or a Car Battery and converter. Facilities for play-back and for sound amplification form an integral part of the Recorder. **RECORDING BLANKS:** EMIDISC Recording Blanks are ready for playback immediately after cutting. They are available in the following sizes—6", 10", 12", 16". **PROCESS BLANKS**—enabling the recording to be pressed in quantity, by E.M.I., are obtainable for 11", 12", 13", 17½" recordings.

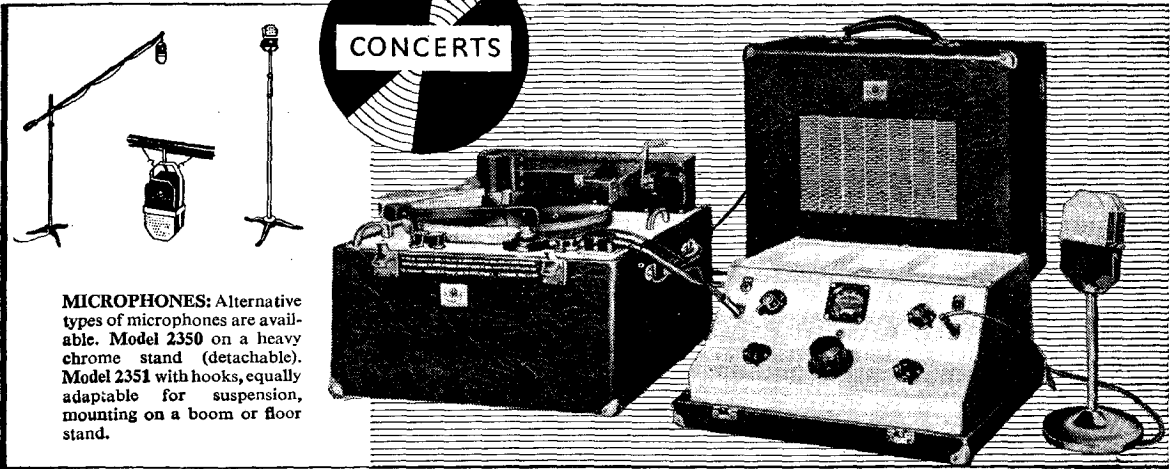
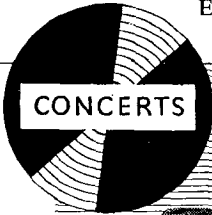

MICROPHONES: Alternative types of microphones are available. Model 2350 on a heavy chrome stand (detachable). Model 2351 with hooks, equally adaptable for suspension, mounting on a boom or floor stand.

A descriptive leaflet giving full details of Model 2300; extra Microphones and Recording Blanks is available on request.



E.M.I. PORTABLE RECORDER No. 2300
E.M.I. SALES & SERVICE LTD. HEAD OFFICE: HAYES, MIDDX.

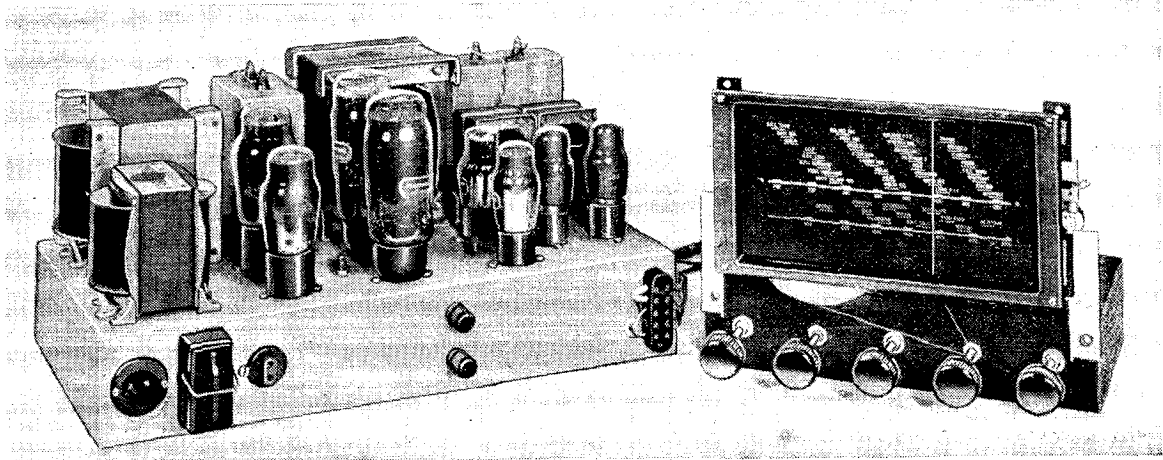

GOODSELL

HI-FIDELITY AMPLIFIERS

As described by D. T. N. Williamson in "Wireless World."

ALSO HI-FIDELITY TUNERS & PRE-AMPLIFIERS

Manufactured by **GOODSELL LTD., 40, GARDNER ST., BRIGHTON, SUSSEX** 'Phone : 6735

PRICES

Amplifiers	from £19 19 0	} No Tax
Pre-Amplifiers ..	from £8 0 0	
Tuners with Pre-Amplifiers	£10 10 0	Plus Tax

Send for free illustrated brochure.

LEARN MORE

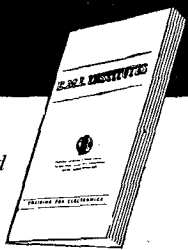

FREE BOOKLET

giving details of home study and daytime courses :-

HOME STUDY

- Practical Radio Receiver Servicing
- Basic Radio } for R.T.E.B.—
- Basic Television } "The practical man's diploma"

DAYTIME

- Principles and Practice of Radio—1 year
- Telecom. Engineering—2 years
- Electronics Engineering—3 years (including 1 year in E.M.I. Factories)

★ The value of E.M.I. Institutes correspondence courses is known the world over—large numbers of our students come from such widely scattered lands as India, Pakistan, Palestine, Ceylon and Europe.

Write to Dept. 16

E.M.I. INSTITUTES

43, GROVE PARK ROAD, LONDON, W.4 CHiswick 4417/B

Associated with
"H.M.V."
MARCONIPHONE
COLUMBIA
ETC.

E.148B

BAKERS 'Selhurst' RADIO

PIONEERS OF MOVING COIL SPEAKERS SINCE 1925

NEW IMPROVED 1950 MODELS

HIGH FIDELITY SPEAKERS

The World Famous
12" triple cone 12.B.

The standard 12"
P.A. model 12.C.

The Cinema Model
18" "Duplex" C.T.

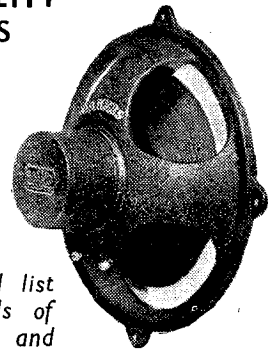

Write for illustrated list and technical details of SPEAKERS, TUNERS and AMPLIFIERS.

BAKERS 'SELHURST' RADIO

Dingwall Road, Croydon

Telephone: CROYdon 2271/2

THIS and THAT

BECAUSE it would have left the 1949 volume with its shirt hanging out, the Editor ruled against beginning my two-part treatise on filters in this December issue. And it may not be such a bad thing anyway; two big helpings of smoothing circuits followed without a break by a similar dose of filters might upset even hardened technical digestions. Something a bit lighter sandwiched between may be all to the good. Even Shakespeare admitted the need for comic relief.

Some time ago a correspondent made an extremely penetrating observation. He argued against the present G.P.O. practice of demanding a separate licence for car radio sets, not because it was an act of social injustice against the new poor, but (as he explained) on strictly technical grounds. By compelling the thrifty motorist to install his aerial under the running board or in some such inconspicuous part of the vehicle, it made mobile reception even worse than it need be. One more example, it would seem, of car design being influenced by the tax-gatherer rather than by the engineer.

Sudden De-licencing

Talking about licences, have you realized that if you (or anyone else) charged for people to come into your house, say for the purpose of getting a good view of a procession from the upstairs windows, your wireless licence, even if you had bought it only yesterday, would forthwith expire? I confess I didn't until I took the unusual step of reading it. This is what it says: "M. Cathode Ray" (or words to that effect) "is hereby authorized . . . for a period ending on the date mentioned above or on any earlier date on which a charge for admission to the premises shall be made by the Licensee or any other person, to install and work apparatus for wireless telegraphy in the premises occupied by the Licensee

"End-of-Term" Relaxation

By "CATHODE RAY"

. . . . " There is nothing to limit this sudden de-licencing to situations where the mercenary activities of the Licensee have anything to do with "wireless telegraphy."

By the way, I suppose that to the legal mind it appears quite fitting to refer to the process that permits us to view our undeniably attractive television announcers as "wireless telegraphy." It reminds me of the enactment authorizing the closing of roads in the Isle of Man for the T.T. races, in which these thrilling events were defined as "the testing of light locomotives."

Such uses of words are quaint old legal customs at which we can smile tolerantly. But I don't feel at all the same about those commercial interests who, either from sheer ignorance or deliberately, try to make an impression on the gullible public by misusing scientific terms as names for their wares. With their high-pressure publicity they sometimes succeed in getting their counterfeit meanings into general circulation first, so that when the genuine article comes on the scene it is mistaken for an imposter. You know the sort of thing—somebody is not satisfied with selling suppressor resistors at the usual one and sixpence, so he calls them cyclotrons or isotherms and charges half-a-crown.

I see it is eleven years since I commented on the mentality of those who started the absurd habit—now thoroughly established—of classifying receivers into two kinds, television and radio. When a thing reaches a certain pitch of absurdity it becomes impossible to caricature it. So I pass on.

People say "What's the use of protesting about sloppy technical

language? You can never change it once it's got a hold." But once upon a time the idea of substituting the new word "resistor" for the universally-used "resistance" seemed quite hopeless; yet it has been done. And "capacitor" is well on the way. There is still more justification for finding and putting into use a word to distinguish broadcast receivers and programmes without vision from those with.

Now that the radio industry has grown up there is much less about it to make fun of than when it was an adolescent. That is why I have of late years been driven to writing so much about solemn things like smoothing circuits and filters. However, there is one thing that makes me rock with mirth every time. It is the thought that several times every day, year in, year out, millions of the ever-patient British public grind away uncomplaining at their tuning controls to change from Light to Home and Home to Light, when all they need do is to push a switch, if they had the spirit to demand it. It isn't even as if sets were so scarce that they were under the counter and the customer was always wrong. There is a buyer's market. But the buyer doesn't seem to have noticed it.

Words and Music

Having from time to time chided the B.B.C. in these columns for maintaining approximately the same depth of modulation for announcements as for brass bands, mighty Wurlitzers, and massive orchestras, I was rather taken aback by published complaints from listeners to the effect that if the volume control was set right for speech, music was too loud. These complaints arose particularly during the summer, as an excuse for turning up the volume control to the discomfiture of the neighbours.

The only explanation that occurs to me is that while music continues to be generally regarded

THIS and THAT—

as something that must be allowed to go on, but not so loudly as to interfere with conversation, there are now many owners of receivers who have ceased to consider spoken broadcasts in that light and insist on actually listening to the words, presumably in the hope (analogous to that of football pool addicts) that some time, some day, someone in a variety programme may say something really funny. A contributory cause may well be that as a result of the popular demand for "mellow" tone, (in pre-war days, when buyers could and did demand), speech can't be followed unless turned well up. If it were not that it would send up the purchase tax too much, and

might interfere with export, manufacturers could incorporate a device for automatically cutting bass during speech and cutting top and most of the volume during music. The trouble would be that the B.B.C. is so seldom content to let us have them separately, so that the device would be in the same sort of dilemma as the chameleon who found himself on a tartan.

While on the subject of colour, my feeling is that though Hallows may wish to increase the number of frames per second in order to prevent things from looking as if they were leaning over when they flash across the television screen, my impression is that viewers couldn't care less. You may remember that focal-plane camera shutters were a success *because*

they did that, making racing cars look as if they really were racing. Television, I think, is at the stage that . . . *teleaudition*, shall we call it? went through when theorists were insisting on the necessity for frequency characteristics level within a few per cent over the whole audible range, and whose efforts were received with such indifference by the listening public. Apart from a clear picture and a rather larger screen than they can get for the money, the only thing the viewing public know that they want is colour.

Well, if Hallows was (as he said) trailing his coat, I may almost be said to have been trailing several bags marked "Fully-fashioned Nylons." But next month, noses to the grindstone once more! Filters . . .

NEW BOOKS

International Radio Tube Encyclopaedia. Edited by Bernard B. Babani. Pp. 410 + lxxxiv. Bernards, Ltd., The Grampians, Western Gate, London, W.6. Price 42s.

THIS voluminous compilation of data on some 15,000 valves of many different countries starts off with four pages in English which explain the tabular matter contained in the body of the book. The following 80 pages repeat this in various languages—French, Italian, Spanish, Portuguese, German, Dutch, Swedish, Norwegian, Danish, Russian, Polish, Czech, Turkish and Hebrew.

The main tables cover receiving and transmitting valves, thyratrons, regulator and control valves, tuning indicators, c.r. tubes and photoelectric tubes.

Valves are arranged in numerical and alphabetical order of their type numbers, and in the case of receiving valves the information given comprises: type of cathode, class of valve, filament current and volts, anode and screen volts and currents, grid bias, cathode-bias resistor, a.c. resistance, g_m , μ , load resistance, power output, base connections and the makers' name.

British, American and Continental types are included as well as many British and American Service types.

The base connections are given with the valve characteristics, and drawings of the bases themselves are included at the end. Standard base designations are not always used. The B8B is not mentioned

but the B8G and loctal, which are interchangeable with it, are given. The American UX bases are not so called but are given various unfamiliar names, such as US4E, US4N, USM4, USM7B, etc.

The book should be extremely useful to anyone who requires to find out the characteristics of a given valve, but does not meet the inverse requirement of indicating what valves have given characteristics.

W. T. C.

Permanent Magnets. By F. G. Spreadbury, A.M.Inst.B.E. pp. 280 + viii. Sir Isaac Pitman & Sons, Ltd., Parker Street, London, W.C.2. Price 35s.

AS the author points out in his preface, permanent magnetism has been known for about 2,500 years, but only since 1910 has there been marked progress in the subject. Since then it has been so rapid that few have been able to keep up with it; yet permanent magnets are used on such a large scale for so many purposes that the need for a comprehensive and up-to-date book on the subject has become acute. The present work fills this need admirably.

Its substantial size is not due to a diffuse style—quite the contrary, for it is notably concise—but to its comprehensiveness. It is, moreover exceptionally self-contained, as the author has not followed the common practice of putting the onus on the reader of looking up innumerable references.

The chapter headings are: 1, Magnetism and the Permanent

Magnet; 2, Permanent-Magnet Materials; 3, Theory of Magnetism; 4, Magnetic Leakage; 5, Applications of Permanent Magnets; 6, Magnet Design; 7, Magnetic Measurements and Measuring Instruments; 8, Magnetization and Magnetizers; and 9, Demagnetization and Demagnetizers. There is, unfortunately, no reference to the rationalized m.k.s. system of units, c.g.s. units being used throughout. The author does not shirk mathematical proofs of his statements, including some that even the most sceptical might be prepared to take as read. In the last two chapters, particularly, all the factors involved are painstakingly investigated, and are illustrated by some examples of the author's design. Readers who may find some of the mathematics rather beyond them, or who are prepared to take the author's word for the findings, should have no difficulty in picking out what they want. Those who have not kept in close touch with the theoretical physics of magnetism will be fascinated by the account of some of the attempts, such as the Stern-Gerlach experiments, to solve the mysteries of permanent magnetism.

The practical problems of design, and especially those resulting from magnetic leakage, are clearly such as to call for specialized study and experience; but all radio engineers should be acquainted with them if only to know what it is reasonable to expect of the magnet designer. This book is an excellent reference for the purpose.

Though the price is perhaps rather high, it can be said that the standard of the book-production is on the same level. M. G. S.

LETTERS TO THE EDITOR

Interference with Foreign Broadcasts + Cathode-ray Tube Limitations + Tone Control Circuits + Record Reproduction + Spoiling New Records

Beacon Interference

MAY I add my astonished censure to "Mikcrobe's" letter in your November issue on the subject of m.f. beacons in the broadcast band?

I say "astonished" as up until I saw "Mikcrobe's" letter I hadn't the faintest notion what caused the interference and had vaguely attributed it to something quite illegitimate and "on the Continent." The idea that it emanated from authorities in this country didn't enter my head.

If you will permit me to say so, I cannot recall having seen this matter raised before in either the correspondence columns or the editorial of *Wireless World*, a fact (if true) which causes me considerable surprise.

With regard to the Wireless Telegraphy Act: does this provide for interference with foreign stations? When I asked the Post Office to investigate some particularly bad electrical interference (before the Act), the engineers ascertained the fact that the Home and Light carriers over-ride the interference, and left saying that proper reception of foreign stations was no concern of theirs.

C. E. KNIGHT-CLARKE.

London, S.W.19.

C.R. Limitations

IN reports on the performance of amplifiers the phrase "no distortion was visible on the screen of an oscilloscope" often occurs.

Many readers may have wondered what this statement really means, for there appears to be little published information on the minimum percentage of harmonic distortion which is visible by means of a c.r.o.

The results of rough tests to obtain some guidance on this point are given below:—

Harmonic	Minimum % visible
2nd	9%
3rd	4½%
4th	3½%
5th	1½%

These figures are probably rather low, as instantaneous comparison between the pure and distorted

waveforms was available. They refer only to the addition of one harmonic to the fundamental.

It would appear from these results that sometimes more faith than is justifiable is placed in the c.r.o. as an indicator of distortion.

E. W. ROYSTON.

Flixton, Manchester.

Tone Control Circuits

IN the article on a High-Quality Amplifier in your October issue, D. T. N. Williamson describes a tone control circuit to provide continually variable treble and bass rise and fall. Whilst

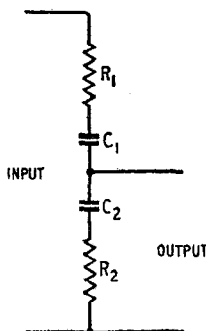

the circuit shown will operate quite satisfactorily at the extremes of control settings, the slope of the rise and fall is by no means ideal at other settings of the controls.

Referring to the basic potentiometer circuit for bass control, Mr. Williamson short-circuits C_1 and applies a variable resistance in parallel with C_2 to provide variable bass boost. This arrangement controls the extent of the boost and does not affect the frequency at which it commences, nor its initial slope. At a low setting it will merely cause a step in the response curve.

Practical tests which we carried out in the development of similar circuits showed that a control which varies the slope of boost is very much to be preferred. Assuming the source impedance can be neglected and the ratio of the reactance of C_1 to R_1 is the same as C_2 to R_2 , then a variable resistance in parallel with C_1 will shift the curve bodily along the frequency axis. If this is coupled with a variable resistance in parallel with C_2 , then a close approach to a variable slope control can be obtained over the essential range.

TRIX

Quality
SOUND EQUIPMENT



TRIX Loudspeakers and accessories are available in a variety of types to suit the needs of every Sound Installation. They are representative of a range of equipment noted for its robust construction and high standard of performance and reliability.

Full details of these accessories and the well-known series of TRIX Amplifiers, Gramo-Radio units, High Fidelity Reproducers and High Power Rack equipment are available on request.

THE TRIX ELECTRICAL CO. LTD.
1-5 Maple Place, Tottenham Court Road,
London, W.1. Phone: MUSEum 5817
Grams & Cables: "Trixdio, Wesdo, London."

AMPLIFIERS · MICROPHONES · LOUDSPEAKERS

Letters to the Editor—

If R_1 is ten times R_2 , then a good compromise can be obtained with a single logarithmic control for rise and fall with level response in the centre of the movement. Close-tolerance components are essential if kinks in the response are to be avoided.

Similar modifications to the treble control can be introduced, although for high frequencies a variable extent of rise and fall is usually more desirable.

Tone control should be applied with the greatest discretion, but a small amount of "compensation" correctly shaped can on occasions prove beneficial. The scale, perspective, or apparent distance of the programme is controlled at the studio and is (or should be) correct for average listening-room level. Variations from this optimum volume level will require only small correction for good balance, always assuming, of course, that the remainder of the equipment does not suffer from deficiencies.

P. J. WALKER.

The Acoustical Manufacturing Co.,
Huntingdon.

The Author replies:—Mr. Walker's letter raises the interesting but vexed question of the most suitable type of bass accentuation. I feel that the answer to this question must depend upon individual circumstances, and that there is no unique solution.

Circumstances can be visualized where the "variable slope" method preferred by Mr. Walker would be distinctly advantageous, but, equally, there are occasions on which raising the general level below, say, 200 c/s can produce more pleasing results. Where the control is to be used solely for the correction of transmission defects, a third type of characteristic,

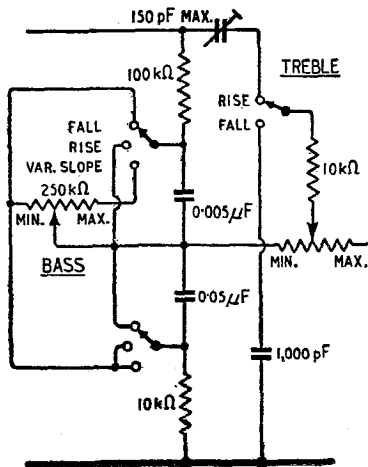

namely, a constant slope of, say, 6 db/octave, the cross-over frequency of which is variable, has much to recommend it. This type of characteristic is used for the treble control. Unfortunately, at low frequencies there is danger of overloading when a characteristic of this type is used for purposes other than the correction of deficiencies of the input.

Where circumstances warrant it, the circuit of Fig. 5 may readily be adapted, as shown in the accompanying figure, to incorporate the type of control recommended by Mr. Walker.

D. T. N. WILLIAMSON.
Edinburgh.

Record Reproduction

IN his article on "Pickup Design" Mr. Marshall rightly suggests that needle scratch is caused more by the rough composition of the material than by an abrasive put in the material by the manufacturer, as has been most popularly supposed in the past.

I should like, however, to draw attention to three points which appear to be somewhat misleading. In his reference to Fig. 4 (a) Mr. Marshall states that the groove is cut with a chisel-shaped edge and that as far as a spherical reproducing point is concerned will vary in width throughout the cycle. He then goes on to say "this is descriptively known as the 'pinch effect'; so that where the stylus is too small, over at least part of the cycle the stylus will lose contact with the groove walls." This latter remark may be true, but it cannot accurately be described as "pinch effect." The groove width varies when modulated, but although it can be smaller it will not usually be larger than the recording stylus size, even with maximum amplitude. "Pinch effect" is the inability of a reproducing stylus of normal dimensions correctly to trace this smaller groove width, causing a riding up of the stylus on the groove walls. A reproducing stylus of optimum dimensions will not be too small, but it may be subject to this "pinch effect."

My second point concerns Fig. 3, where Mr. Marshall says "It will be seen that point B . . . will only just fit this particular groove . . ." In fact, it will be seen that point B does not fit the groove, but rides on the bottom, a condition almost as bad as that shown in Fig. 3 (c). Most modern records of British manufacture have a groove width of 0.0067 in, a radius of 0.0015 to 0.0018 in, an angle of between 85 and 90 degrees, and a depth of 0.0027 in. It will usually be found that a re-

producing point with a radius of 0.0025 to 0.003 in will satisfactorily trace both old and new records.

Third, radius compensation is rarely, if ever, resorted to in commercial gramophone records in this country, although most 33½ r.p.m. transcription records use it to a greater or lesser degree. Amplitudes in the higher end of the frequency scale are so small that a "boost" in recording of, say, 6 db at 10,000 c/s can be tolerated, but the "boost" of between 15 and 30 db, which is so often found in American recordings, can be the cause of considerable distortion.

RICHARD W. LOWDEN.
Farnborough, Hants.

Spoiling New Records

IN view of the high quality (and cost!) of the modern gramophone record it is very galling to find that a new disc has been ruined by demonstration on obsolete reproducers such as are still to be found in many shops. I know of one, 1934 vintage, the needle of which is changed once a day, with luck!

Might I suggest to the makers that they put a proper seal on the envelopes so that one may be sure of a record in mint condition?

Returnable demonstration records would fill the gap until good reproducers are installed.

J. E. ELLIS.
Harrow, Middx.

"High-voltage Measurements"

IHAVE read with interest the article in the October *Wireless World* describing a peak voltmeter.

It may be of interest to know that the Osram U37 valve could be used with advantage in the circuit. It gives:

1. Instantaneous operation with a possibility of push-button control, due to its directly heated filament.
2. The possibility of using only one dry cell for filament heating.

F. E. HENDERSON.
The General Electric Co.,
London, W.C.2.

"Q and L" Measurements

IN saying that my statement "Frequency is the most accurately-measurable quantity there is" was misleading in relation to the measurement of Q, W. T. Cocking (your November issue) has taken it out of its context. It occurred in a section devoted to the meaning and measurement of Q at such high frequencies that L and C are not separately measurable. So it was not quite the right text on which to hang his very instructive sermon on

OUR COVER

The acoustic characteristics of the anti-echo loudspeaker testing chamber at Plessey's, which is illustrated on our front cover, are comparable with those of free air. This erstwhile air-raised shelter has been lined with wedge-shaped blocks of sound insulating material to render it almost completely non-reflective. The free space area of the chamber is 12ft x 9ft x 6ft 9in.

the advantages of the capacitance-detuning method!

As regards even the general truth of the statement there can hardly be any question, for the accuracy with which frequency is known is several orders of magnitude better than that of any other quantity used in radio measurements. The G.P.O. reckon they have it within ± 1 in 10^8 , but what is more remarkable in its way is that any owner of a broadcast receiver has at his disposal one audio-frequency and several radio-frequency standards accurate to ± 1 in 10^8 . With quite cheap apparatus and a good deal of patience, these can be interpolated over the whole useful range of frequency in a positive manner—cheap, that is to say, when compared with the cost of a standard variable capacitance one thousand times less accurate.

For frequencies at which capacitance is measurable at all, I entirely agree with Mr. Cocking about the greater convenience of the apparatus for the capacitance-detuning method. But unless one cheats by buying two accurately calibrated variables, one of them reliable within 0.1 pF, how does one get these calibrations? Surely by a method based on known frequencies! The thing I dislike about capacitance measurements is the uncertainty of the absolute value, especially when there are several items in parallel, including a self-capacitance; and at the frequency of 40 Mc/s referred to by Mr. Cocking the errors due to distributed reactances and the necessary auxiliary measurements of L and C₀ are usually regrettably large.

Mr. Cocking goes rather out of his way to make the frequency method look worse than it is. Anybody with the sense to use a separate low-reading capacitor for measuring ΔC would hardly make the elementary blunder of trying to read Δf on the same frequency scale as f ! His point, of course, is that one might have to, for lack of the elaborate apparatus he describes. There are, however, reasonable methods of obtaining a known Δf without any

crystals or anything at all more elaborate than a fixed audio frequency that has been set to a multiple of the B.B.C.'s standard 440c/s broadcast daily. The horrid example of what would happen if one were to measure Δf as the difference between two nearly equal frequencies with errors of +1% and -1% respectively is as unrealistic as measuring the height of a man by taking the difference between two independent measurements of height above sea level.

Incidentally, in view of Mr. Cocking's basis of distinction between Q-meters (direct-reading) and Q-measuring methods (which arrive at Q by calculation), it may be necessary for me to repeat that most so-called Q-meters do not give true Q without subsequent calculation. The practical significance of true Q having been called into question,* a main point of my article was to reinstate it. Nobody appears to have questioned the reinstatement.

"CATHODE RAY."

* *Wireless World*, June, 1949, p. 216.

MANUFACTURERS' LITERATURE

FOLDER (Y13, printed in three languages), describing "Solon" electric soldering irons, from W. T. Henley's Telegraph Works Co., 51 and 53, Hatton Garden, London, E.C.1.

Leaflet (CL534), giving details of "Tom Thumb" service replacement electrolytic capacitors, from A. H. Hunt, Bendon Valley, Garratt Lane, London, S.W.18.

Illustrated leaflets describing "Volmar" electric gramophones and record players, made by Industrial Sound Equipment and sold by the General and Overseas Trading Corporation, 6, Duke Street, London, S.W.1.

Catalogue of data sheets relating to the Type 103 cathode-ray oscilloscope made by Nagard, Ltd., 245, Brixton Road, London, S.W.9.

Catalogue (D) of "Eclipse" permanent magnets from James Neill & Co., Napier Street, Sheffield, 11.

Details of Record "Major" insulation tester (500 V, range 0-50 MΩ) from the Record Electrical Co., Broadheath, Altrincham, Cheshire.

Illustrated leaflet (No. 40), dealing with the new range of precision-ground ceramic radio coil formers, from Steatite & Porcelain Products, Stourport-on-Severn, Worcs.

Brochure describing television aerial service and new aerial types, from Validus Aerials, 69, Hornsey Road, N.7.

A new conception in Television Aerials

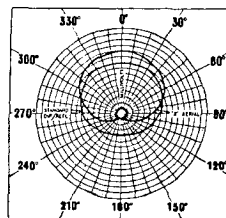

Horizontal Polar diagram at 45 Mc/s. The Forward Gain of the "Antex" Aerial is 2db better than a standard "H" array.

THE "ANTEX" (REGD.) Greater Signal Strength Greater Noise Cut Less weight - Less Cost

Antiference research and engineering knowledge once more lead the way with this revolutionary new "ANTEX" (Regd.) Aerial. With front-to-back ratio of 22.0 db and a forward gain of 2 db when compared with the standard 'H' aerial, it brings a new level of quality to television reception.

The electrical and mechanical design of this aerial is protected by Prov. Pat. Nos. 35957/46 and 12178/49 and Regd. Design No. 859630.

FRONT/BACK RATIO

Standard Dipole and Reflector ('H' array) — 7.5 db, "ANTEX" AERIAL ('X' array) — 22.0 db

MODEL XL for London; XL/B for Birmingham, including 7-ft mast and chimney lashing equipment as illustrated. - - - £3-15-0

MODEL XW for London; XW/B for Birmingham, including 7-ft mast and wall mounting bracket - - - £3-0-0

ANTIFERENCE

LIMITED

67 BRYANSTON ST., LONDON, W.1.

RANDOM RADIATIONS

By "DIALLIST"

Capacitors as Dry Cells

YOU REMEMBER my recording a while ago instances of misbehaviour on the part of old paper-dielectric capacitors, which had so far forgotten their mission in life as to turn into dry cells, each with a definite polarity and terminal potential differences of from 0.1 to 0.4 volts? Several readers who have examined their stocks of old capacitors confirm that this kind of thing is by no means uncommon. In some instances capacitors tested with valve voltmeters with an input resistance of 20-50 MΩ have shown p.d.s as high as 3 volts. That these arise from genuine e.m.f.s and are not just static charges is proved by the fact they have a definite polarity and that they persist even after repeated short-circuitings of the terminals. I suggested, you may recall, that a capacitor mistaking its vocation in this way might give rise to some queer effects in a receiving set. A kind Irish reader sends me a record of one that did. In a t.r.f. battery set the manual volume control worked by varying the bias on the grid of the r.f. valve. Reception had become very weak and the v.c. was out of action; examination showed that its sliding contact had broken off. Tests disclosed a steady bias of 2V negative on the control grid—a surprising state of affairs, since the grid had apparently no d.c. connection to anything. Between the bottom end of the grid coil and the earthed chassis was a 0.5 μF paper capacitor. Due to the breakdown of the volume control it, too, was able to apply to the grid the whole of the 2V e.m.f. which it was found to be generating; and that was sufficient to reduce the set, with its pretty well worn out valves, almost to silence.

Ingenious!

Another reader offers an explanation of the e.m.f.s from old capacitors recorded by the valve voltmeter which is at any rate highly ingenious. In capacitors of

old types, he writes, there is usually quite appreciable inductance. This, with the capacitance, would form a resonant circuit. The leads to the meter act as an aerial; oscillations at, or in the neighbourhood of the resonant frequency are picked up, a voltage appears across the circuit and is duly registered by the valve voltmeter. This e.m.f. varies from capacitor to capacitor because differences in their inductance and capacitance may sometimes produce a circuit resonating at a frequency quite close to that picked up by the meter leads and at other times one which is more or less "off tune" Ingenious, as I've said; but I'm afraid it won't work. Any capacitor, you see, which behaves in this way is invariably found to have a definite and fixed polarity; like a dry cell, it has its positive and negative terminals. If the resonant circuit explanation were correct, the meter reading would not be affected if the capacitor connections were reversed.

It Doesn't Make Things Easy

WHAT A PITY it is that there can't be some kind of international uniformity in the use of the symbols—letters, figures, punctuation marks, lines, and so on—by means of which authors put their ideas on to paper and readers endeavour to discover what they are trying to convey. One is always coming across instances of the difficulties created—quite unnecessarily—by the lack of a single world-wide system in these things. When, for example, we express in figures two thousand six hundred and eighty-three point four seven we write 2,683.47; but in many other countries it appears as 2.683,47, the point and the comma having exchanged roles. A trillion with us is 10^{12} ; elsewhere it may be 10^{12} —it certainly is in France and I think in the United States. Our practice seems the more logical, for our trillion is the third power of a million; a quadrillion, the fourth

power, and so on. One of the most annoying bits of perversity I've come across is the habit at which at any rate some French publications have of turning the symbols for cell or battery upside down. I used to think that the use of a longish thin line for the positive end and of a short fat one for the negative end really was universal. The other day, though, I could not see from a circuit diagram in a French publication how a gadget containing two batteries could possibly work—until I realized that the short fat lines were there the positive ends of the batteries and the longer thin lines the negative.

Radio Roundabout

FROM A MEDICAL READER comes a query about alleged effects of wireless waves on pigeons. It was solemnly stated, I gather, by someone at a meeting of medicos that carrier pigeons released near a certain transmitting aerial circle round it indefinitely when a particular wavelength is in use. He asks whether the report is fact or fiction. I have no hesitation in plumping for the latter. Tales of this kind are continually cropping up and, to the best of my knowledge, investigations have always shown them to be pure bunk. Carrier pigeons invariably circle when released, gaining height as they do so. It is some little time before they get their bearings and make a bee- (or pigeon-) line for home. Release a basketful near any high aerial mast and the odds are that they'll probably circle round it for a while. That, possibly, was the "proof" given to the lay journalist who wrote the original story. Experiments have been made in America with a view to discovering whether e.m. radiations of certain frequencies could have any effect on birds. The scale of the experiments was too small to be conclusive, but no definite or sustained effects were recorded. Actually, when you come to think of it, experiments of the same kind are conducting themselves on a vast scale on every day of the year in this country. Pigeon flying is a popular hobby, especially in the North. Enormous streams of migrant birds of many kinds pass into, through, and out of Britain. At any moment there must be radio, radar and television aerials radiating on wavelengths of every

order from centimetres to kilometres. Nobody to my knowledge has ever observed birds of any kind circling willy-nilly round any of these aeri-als.

The Practical Aspect

My correspondent wonders whether, if the story were true, the pigeons would fly always either right-about or left-about. I wonder, too! Presumably, those which were the subject of the alleged report described their circles in the horizontal plane. The radiations would most likely be vertically polarized. A really convincing demonstration could have been arranged by providing a change-over switch and an aerial for horizontal polarization as well. Flicking over the switch should then have caused the birds to describe circles in the vertical plane—which would have been well worth seeing!

Some Television Station!

By THE TIME that these notes are printed the Sutton Coldfield television station is sure to have started test transmission, if it is to be ready (as doubtless it will be) for the opening ceremony on December 17th. I expect to hear of good reception at quite considerable distances at places on high ground. As the output power is just over twice that of the Alexandra Palace station, one would expect the service area to have a radius nearly one-and-a-half times as great in any event. I believe, though, that this radius may well turn out to be the best part of 60 miles in most directions. The station is well sited and some of the "fringe-area" receiving aeri-als now available are remarkably good performers. And I'm betting that soon after the station comes into action there'll be reports of consistently good reception at points 100 miles or even more away. Sutton Coldfield is a station for whose existence the country in general and the B.B.C. in particular may well feel that pats on the back are deserved. It is by far the most powerful television station in the world and I doubt whether there are many others anywhere which can as justly claim a vision modulation range of 2.75 Mc/s without appreciable amplitude—or phase—distortion. It's a fine Christmas present to Birmingham and the Midlands.

More than a SWITCH — a SERVICE!

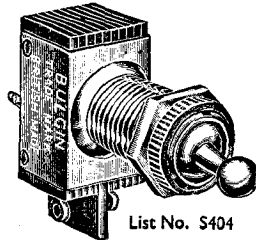

List No. S.404

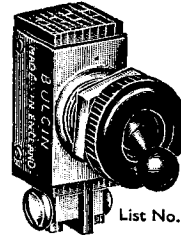

List No. S.478

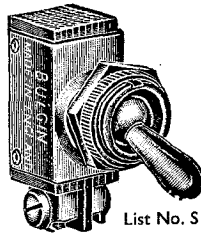

List No. S.258 P.D.

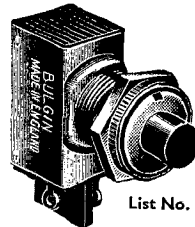

List No. S.365

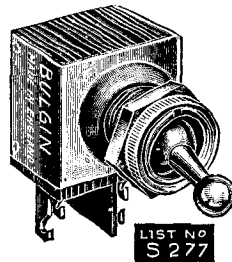
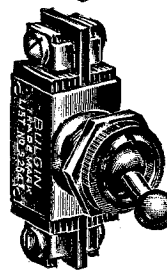
LIST No
S 277

List No. S.264

The experience of 25 years behind every switch!

Famous 2-pole M.-B long bush Toggle Switch. This model is suitable for 6-250V. circuits; max. 1A, for all panels up to 9/16" thick. List No. S.404.

Pear dolly for easy operation; for circuits as above. All BULGIN switches are obtainable with a wide variety of dollies, fixing nuts, bushing rings, and finishes, on request. List No. S.258 P.D.

Double-pole general purpose M.-B. for similar circuits at 3A. max. Silver plated roller-action contacts. List No. S.277.

New version of long-popular single-pole M.-B model, for 6-250V., 3A. circuits. Note the insulated front ring, available on all switches at request. List No. S.478

Press ON; biased OFF. A popular model for 6-250V. circuits; max. 3A. List No. S.365. (Reversed action; List No. S.366)

Change-Over switch, single-pole. New version with terminals, for 6-250V. circuits; max. 2A. Guaranteed — as all BULGIN switches — for at least 25,000 operations! List No. S.264.

BULGIN

Components

ILLUSTRATED
COMPONENT
CATALOGUE
Price 1/-
Post Free

"The
Choice
of
Critics"



A. F. BULGIN & CO., LTD.
BYE PASS ROAD, BARKING, ESSEX
Telephone: RIPPleway 3474-8

RECENT INVENTIONS

A Selection of the More Interesting Radio Developments

C - R Tubes

FOR producing a high-intensity electron beam one method is to heat a thermionic cathode by electronic bombardment; thereby high temperature operation may be secured while maintaining a long operating life, as well as other advantages. However, it is difficult to avoid disturbing effects due to secondary electrons resulting from the bombardment. These difficulties are avoided by the fact that bombardment is only effected periodically during the operating cycle by making the cathode periodically positive relative to the source of bombarding electrons; for television or oscilloscope use the bombardment is effected during the flyback intervals of a scanning process.

In a practical circuit a filament heater surrounds the cathode proper and the latter is coupled through a diode to a transformer energized from a time-base generator and arranged to make the cathode positive to the heater during the flyback, and thus effect the bombardment heating of the cathode during the same period.

Cinema-Television, Ltd., and W. H. Buchanan. Application date, July 10th, 1947. No. 624,832.

F.M. Receivers

THE accurate tuning of f.m. receivers is difficult because there is usually an increased response on each side of

the correct position. To avoid this difficulty the amplitude limiter provides a muting voltage which is operative when the receiver is detuned from the signal.

In the circuit diagram *a* represents the i.f. amplifier, the output of which is fed to an amplitude limiter *V₁*, and thence to the detector, e.g., the twin diodes *V₂*. Negative voltage is applied to the grid and cathode of *V₁*, the

screen of which is earthed. *V₃* is an a.f. amplifier, which is fed from the diodes *V₂*. The anode current of *V₁* is a maximum for zero signal and decreases as the f.m. signal amplitude increases, due to grid rectification. This current produces a voltage across *R₁* which is fed to the grid of *V₃* through *R₂* to mute the a.f. circuits. At the correct tuning point, however, the anode current of *V₁* is so small that muting is ineffective and the receiver gives normal a.f. output.

Marconi's Wireless Telegraph Co., Ltd. (assignees of A. Wright). Convention date (U.S.A.), November 6th, 1945. No. 625,449.

Chassis Construction

IN unit chassis construction, e.g., for i.f. amplifiers and for other sec-

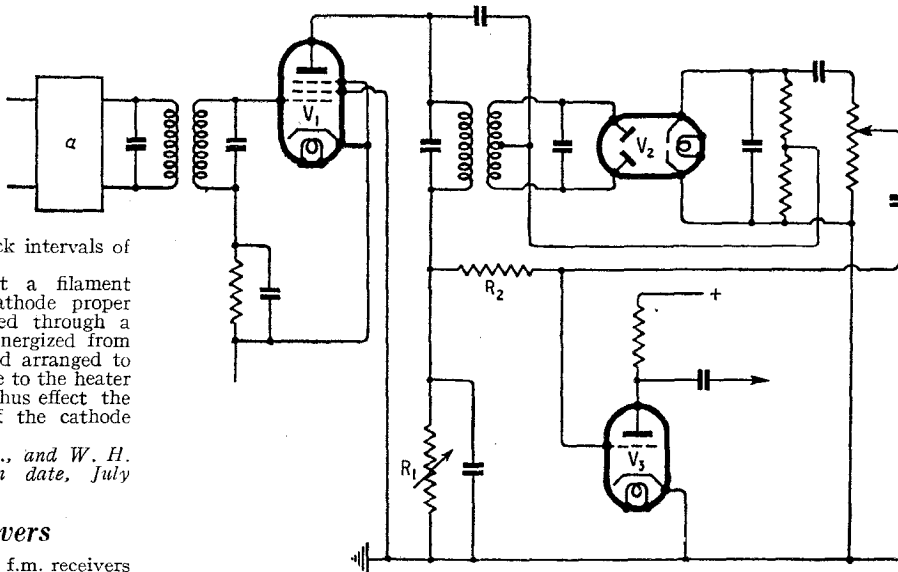

Muting circuit for f.m. tuning.



Books Published for "Wireless World"

	Net Price	By post
RADIO DATA CHARTS, by R. T. Beatty, M.A., B.E., D.Sc., Fifth Edition—revised by J. McG. Sowerby, B.A., A.M.I.E.E.	7/6	7/11
GUIDE TO BROADCASTING STATIONS. Fifth Edition ...	1/6	1/7
RADIO VALVE DATA. Characteristics of 1,600 Receiving Valves ...	3/6	3/9
FOUNDATIONS OF WIRELESS. Fourth revised Edition, by M. G. Scroggie, B.Sc., M.I.E.E.	7/6	7/10
RADIO LABORATORY HANDBOOK. Fourth Edition, by M. G. Scroggie, B.Sc., M.I.E.E.	12/6	12/11
WIRELESS SERVICING MANUAL, by W. T. Cocking, M.I.E.E., Seventh Edition ...	10/6	10/10
TELEVISION RECEIVER CONSTRUCTION. A Reprint of 10 articles from "Wireless World" ...	2/6	2/9
WIRELESS DIRECTION FINDING. By R. Keen, M.B.E., B.Eng.(Hons.), Fourth Edition ...	45/-	45/9

A complete list of books is available on application

Obtainable from all leading booksellers or from

ILIFFE & SONS LTD., Dorset House, Stamford Street, London, S.E.1.

tions of apparatus using thermionic valves, difficulties are sometimes met with when using valves having a base grid terminal. The construction described divides the valveholder between adjacent units. An i.f. unit might comprise a screening box having that part of the i.f. valveholder carrying all except the grid and anode terminals, the i.f. transformer and the part of the holder of the following valve containing the grid and cathode terminals. The holder parts match with other parts to form complete holders, when the units are assembled.

Philips Lamps, Ltd. (Convention date (Netherlands), September 14th, 1943. No. 626,142.

The British Abstracts published here are prepared with the permission of the Controller of H.M. Stationery Office, from specifications obtainable at the Patent Office, 25, Southampton Buildings, London, W.C.2, price 2/- each.